

ADVENTURES IN FIBER OPTICS KIT

25 DO-IT-YOURSELF
EXPERIMENTS & PROJECTS

for Ages 10 through 15

INDUSTRIAL FIBER OPTICS

Introduction

Welcome to the fascinating world of fiber optics technology! Not long ago, fiber optics was little more than a laboratory curiosity. Physicists and scientists in research labs were the only people doing much work in this field. Components were typically high-priced, unavailable, or had to be made from raw materials. Generally, fiber optics was considered a very special field of optics with few real applications. No company then in existence specialized in fiber optics.

In the last 20 years all this has changed. Although the precise origins of fiber optics are hard to define (one might say the "beginning" occurred when light was created), many knowledgeable people contend the turning point was the successful demonstration of a fiber optic telephone line in 1976 by the Bell Telephone System. Since then, fiber optics has become one of the breakthrough technologies world-wide. From obscure beginnings in the back of a lab, fiber optics has become the major advertising focus of communications giants such as AT&T, Sprint and MCI, and it has simplified many medical procedures. Fiber optics is now a leading edge technology. It employs many of the world's brightest engineers and scientists working in companies of all sizes.

*We hope you enjoy your Adventures in Fiber Optics Kit. In it are 20 action-filled experiments and five projects to impress your friends, parents and fellow students. We hope it exceeds your expectations and provides you with many hours of interesting and stimulating activities. At this time please inspect your kit and identify every item in the Kit Components list. If any items are missing, please see the section entitled **"Missing Parts & Warranty Information."***

Table of Contents

Introduction	
Metric Units of Measure	<i>ii</i>
Kit Contents	<i>ii</i>
Additional Items Required	<i>iii</i>
Missing Parts & Warranty Information	<i>iii</i>
Experiments	
Introduction to Fiber Optics:	1
Bending the Light Guide	2
Light Makes Its Escape	3
Modern Optical Fiber	4
Testing Fiber Cladding	5
Tyndall's Prestigious Experiment	6
Special Optical Effects	7
Optical Fiber is Tough Stuff	8
A Rock Called Vlexite	9
Fiber Faceplates	10
Making Your Own Image Conduit	11
Fiber Optics and Lens:	12
The Art of Polishing Glass	13
Visual Clarity Comes in Bundles	14
Fiber Does the Bends	15
Fiber Optic Image "Inverters"	16
Flexible Fiber Bundles	17
More Fiber and Lenses	18
Fluorescence	19
Molecular Structures	20
Projects	
Create a Fiber Optic Wand	21
Lighting the Stars	22
Personal Holiday Tree Ornament	23
Putting Your Name in Lights	24
Fiber Optic Image Magnifier	25
Congratulations	26

IMPORTANT SAFETY PRECAUTIONS:

Some of these experiments require that you heat and bend objects to create different, permanent shapes. You must wear gloves or use cloth padding to protect your hands when performing these procedures. In addition to using gloves or padding, we suggest you wear safety glasses or goggles when heating and bending any of the components into different shapes. Adult supervision is advised.

Metric Units of Measure

The Metric System is the primary unit of measure used throughout this kit because fiber optic technology was developed using the Metric System. For those of you prefer, the English measurement system of inches, feet, etc., has been listed in parentheses behind the metric in most cases. The English dimensions may not always be exact conversions.

Kit Contents:

The items below are found in your Industrial Fiber Optics **ADVENTURES IN FIBER OPTICS KIT** and will be used in completing the experiments and projects found in this manual. The items are listed in the order in which they are used in this manual. The items are described by their physical size or color and their technical names. To identify these components go through the list and pick out the items that you can easily identify by their physical size or color. Once you have identified the obvious ones go through the list again. After several passes through the list you will find that you have successfully identified every item. If any items are missing or damaged in your kit, please go to the section entitled "**Missing Parts & Warranty Information**" for assistance.

- 1 Penlight
- 1 Black rubber penlight "boot"
- 1 3 mm (1/8 inch) diameter acrylic rod, 30 cm (12 inches) long
- 1 2 mm (.08 inch) diameter optical fiber, 50 cm (20 inches) long
- 1 2.2 mm (.088 inch) outside-diameter jacketed optical fiber, .75 m (30 inches) long
- 1 Ulexite crystal (off-white, irregular-shaped rock)
- 1 10 × 10 × 2.5 mm (.4 × .4 × .1 inch) fiber optic faceplate
- 1 25 × 25 × 6 mm (1 × 1 × 1/4 inch) piece of clear plastic
- 10 .5 mm (.02 inch) diameter plastic optical fibers, 1 m (39.4 inches) long
- 1 9.5 mm (3/8 inch) diameter black heat shrink tubing, 2.5 cm (1 inch) long
- 1 2000 grit polishing paper (dark gray color)
- 1 3 μm polishing film (pink color)
- 1 Lens, double convex, 25.4 mm (1 inch) diameter
- 1 3 mm diameter × 4.3 cm (1/8 × 1-3/4 inch) image conduit (glass-like rod)
- 2 Small binder clips
- 25 .25 mm (.01 inch) diameter plastic optical fibers, 1 m long (39.4 inches)
- 1 3 mm (1/8 inch) diameter white heat shrink tubing, 7.5 cm (3 inches) long
- 3 Rubber bands
- 1 1 mm (.04 inch) diameter red and green plastic optical fiber, 15 cm (6 inches) long*
- 1 3 mm (1/8 inch) black heat shrink tubing, 15 cm (6 inches) long
Red, green and blue gel filter material
- 1 Star/constellation map
- 1 20 × 20 cm (8 × 8 inch) Foamcor® mount
- 2 Twist ties
- 1 Holiday wreath or tree
- 1 2.5 cm (1 inch) diameter acrylic cylinder, 10 cm (4 inches) long
- 1 2.22 cm (7/8 inch) diameter acrylic cylinder, 5 cm (2 inches) long
- 1 3 mm diameter × 2.5 cm (1/8 × 1 inch) image conduit (glass-like rod)
- 1 12 mm (1/2 inch) diameter clear plastic ball

* Larger or smaller diameter fiber maybe substituted for variety.

Additional Items Required:

Listed below are additional common household items that you will need to complete the projects and experiments in this kit. In each experiment or project, the items needed will be listed under *Materials Needed*. The items not included in this kit (you will need to furnish them) will have an asterisk (*) following them.

- 2 AA batteries
- Alcohol lamp, Bunsen burner or propane torch
- Gloves, or two pads of cloth
- Safety glasses or goggles
- 1 Single-edge razor blade
- Pan which will hold water a depth of 5 cm (2 inches) A cake or bread pan works well.
- Empty 1-gallon plastic milk container (washed and cleaned)
- Blow dryer (as used for blow drying hair)
- Scissors
- Ball point pen
- Hot glue gun*
- Aluminum foil
- Hammer
- Ruler
- Water, light oil or glycerin, 10 ml (.5 oz)
- Toenail clippers
- Isopropyl alcohol
- Cotton swab
- Roll of paper towels
- Roll of masking tape 15 cm (1/2 to 3/4 inch) wide
- Three-sided file (a small emery board nail file will also work)
- Pliers
- Pencil
- Pin (the type used in sewing)

* Clear silicone glue can be used instead of the hot glue and gun throughout this kit, but you will need to wait for the silicone to dry (usually several hours).

Missing Parts Claims & Warranty Information

This kit was carefully inspected before leaving the factory. Industrial Fiber Optics products are warranted against missing parts and defects in materials and workmanship for 90 days. Since heating and incorrect assembly can damage components, no warranty can be made after assembly has begun. If any parts become damaged, we suggest that you contact the company from which this kit was purchased, since such companies often carry the items contained in this kit as individual components. If you need replacement items immediately, you may also consider local electronics stores, hobby shops or specialized retail science suppliers.

You may also send us a letter describing the item you need. (Address can be found at the rear of this manual.) Include \$5 (U.S. funds) in check or money order for the first item and \$2.50 for any additional item thereafter. We will send the item(s) to you by first class mail. Be sure to include your return address in your letter and allow about two weeks for delivery.

1

Introduction to Fiber Optics:

What exactly is Fiber Optics?

One dictionary defines *fiber optics* as:

1. The branch of optics dealing with the transmission of light and images, as around bends and curves;
2. The fiber thus used.

In our first experiment we will show how a simple plastic rod can guide light from one point to another in a "fiber optic" manner.

Materials Needed:

- Penlight (you must provide and install 2 AA batteries)
- Black rubber penlight boot
- 3 mm (1/8 inch) diameter plastic rod, 30 cm (12 inches) long

FOLLOW THESE STEPS:

- Dim the room lighting and turn on the penlight. Point it at a wall. Observe the size of the light beam on the surface as you move the light closer to the wall. Notice the beam size when the light is approximately 30 cm (12 inches) away.
- Fit the black rubber boot over the bulb end of the penlight, then insert one end of the plastic rod into the hole in the rubber boot.
- Observe the bright white light which appears at the other end of the acrylic rod.
- With the plastic rod in the boot, point the rod tip toward a wall and observe how the size of the light spot changes as you vary the distance from rod tip to the wall.
- Look carefully to see if you can observe any light inside the plastic rod. (It may be necessary to go into a dark room.)
- Now grip the plastic rod in the middle by clutching it inside your fist. Is the intensity of the light coming from the tip now more, or less, than it was before you gripped the rod? Turn the penlight off.

RESULTS:

Light from the penlight bulb should enter one end of the plastic rod and exit the other end. When the tip of the rod is close to the wall, the size of the light beam should be small. When you dim the room light you should see light a small amount of light inside the rod.



WHY:

Light entering one end of the acrylic rod is trapped inside until it exits the other end. This happens because of a material characteristic called optical density. The optical density of the rod is greater than the optical density of the air around the rod. Because light is confined in the rod, it doesn't spread until it leaves the tip. Contrary to popular belief, light can't be seen as it passes through the air. The "light beam" you may see traveling through space from the projector in movie theaters is actually light being reflected off dust particles in the air. The light you see inside the rod is caused by imperfections in the plastic which cause light to scatter.

HISTORICAL NOTE:

German mathematician and astronomer Johannes Kepler (1571-1630) is known chiefly for his discovery that the planets move in elliptical (oval-shaped) orbits. However, he also published a book in 1604 called *Astronomiae pars Optica*. The publication explained, with the help of several experiments, how light travels in straight lines, casts shadows, and bends when it moves from one substance to another. He was well ahead of his time.

2

Bending the Light Guide

Optical fibers can transfer light through bends and curves

True optical fibers can do more than transfer light from one end to the other through an established path. In this activity we will bend the plastic rod to further demonstrate the rod's "light-guiding" properties and how light can be "persuaded" to travel around bends and curves.

Materials Needed:

- Penlight with batteries
- Black rubber penlight boot
- 3 mm (1/8 inch) diameter plastic rod, 30 cm (12 inches) long
- Alcohol lamp, Bunsen burner or propane torch*
- Pair of cotton gloves or cloth pads*

* Not contained in this kit.

FOLLOW THESE STEPS:

- Place your heat source on a firm flat surface. Light the fuel with a match and adjust the flame until it burns steadily.
- Remove the plastic rod from the rubber boot. Using gloves or cloth pads, carefully grip each end of the rod. Hold the center of the rod above the flame and heat a central area about 10 cm (4 inches) long. Rotate the rod so it heats evenly.
- When the center of the rod is flexible, remove it from the heat and quickly bend the rod into a "U-shape" as shown in the illustration here. Turn the heat source off and allow the rod to cool for at least five minutes.
- Insert one end of the curved rod into the hole in the rubber boot on the penlight, and turn the penlight on. Observe the light coming out the other end of the rod. Is the light's intensity the same, greater, or less than before you bent the rod? Turn the penlight off.

RESULTS:

The light should travel from end to end in the "U-shaped" rod just as well as in **Experiment 1**. Any decrease in light intensity should be very slight.

WHY:

Light traveling inside the straight acrylic rod actually "bounced" back and forth off the inner walls of the rod many times, at very small angles. Even when the acrylic rod is bent, light strikes the interior walls of the rod at pretty much the same angles. Light continues to travel from one end to the other just as it did when the rod was straight.

HISTORICAL NOTE:

Egyptian geographer Ptolemy (AD 90-168) probably devised the first "laws" or scientific theories that predicted how light would interact with matter. Sometimes his theories worked; sometimes they didn't. It was Willebrord Snell (1580-1626), a Dutch mathematician and astronomer, who refined these principles to what we know and use today in predicting how light rays will act when they encounter optical materials like our acrylic rod.

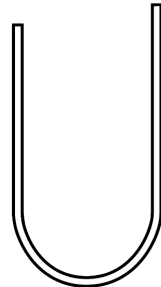

1171

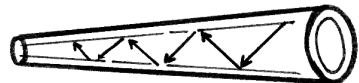

1153

3

Light Makes Its Escape

The light-carrying portion of an optical fiber must be protected

In this activity you will observe how changing the optical density (refractive index) of the material surrounding the acrylic rod will affect the rod's light-transmitting ability.

Materials Needed:

- Penlight with batteries
- Black rubber penlight boot
- 3 mm (1/8 inch) acrylic rod bent into "U" shape from **Experiment 2**
- Pan of water about 20 cm (8 inches) wide and 5 cm (2 inches) deep*

* Not contained in this kit.

FOLLOW THESE STEPS:

- Turn the penlight on. Insert one end of the U-shaped rod into the black rubber boot (if you removed it previously.) Slowly immerse the bent portion of the rod in the water, but be careful to keep the penlight and rubber boot out of the water.
- As you immerse the rod in the water, observe the amount of light coming out the end of the rod.
- Now dim the room lights, immerse the rod in water and again observe the light as it travels through the rod. Can you see light escaping from the rod? Where does the light go? Turn the penlight off.

RESULTS:

As the bottom of the U-shaped rod is immersed, the amount of light coming out the far end of the rod decreases. When the room lights are dimmed you should be able to see light escaping from the plastic rod by looking at the bottom of the pan.

WHY:

The decrease in light from the rod end is caused by the change in optical density outside the rod when it is dipped in water. The optical density of water is closer to that of the rod than the optical density of air; therefore, it doesn't trap light as well. When the light in the rod encounters the water, some of it escapes and travels to the bottom of the pan. The U-shape in the plastic rod increases the amount of light escaping when it is immersed in water.

FIBER OPTIC FACTS:

"Optical density" as we have described it previously may seem a little vague. The scientific term for optical density as we have applied it really is "refractive index" or index of refraction. The refractive indices of the three materials that you worked with in this experiment are shown in the table at the right.

You might now ask: What good are optical fibers if their ability to transmit light can be affected by conditions around them? If this were actually the case, they would not be very useful. Most fiber optics used for commercial applications are manufactured with a coating around the central light-carrying portion so that external conditions do not affect them. This coating is called "cladding" while the central "light-carrying" portion is called the "core". A fiber's cladding always has a lower refractive index than the core.

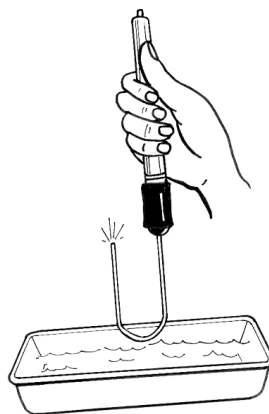

1154

Water	1.33
Acrylic (plastic)	1.45
Air	1.0

4

Modern Optical Fiber

Commercial fiber is very pure and has a protective "cladding"

The acrylic rod used in previous experiments carries light from one end to the other, but it doesn't really do a very good job. To transmit light long distances, commercial optical fibers must be composed of ultra-pure transparent materials. For example, some commercial optical fiber material is so pure that the light lost when traveling through a one-kilometer (5/8 of a mile) length is more than 90 percent of the light which entered the fiber.

In the illustration to the right is a basic optical fiber, with concentric layers of core and cladding. The fiber you will use in this experiment contains a central "light carrying" core and a very thin (10 μm /.0004 inches) cladding layer to trap the light inside. (The cladding is also transparent. You probably won't be able to distinguish it from the core.)

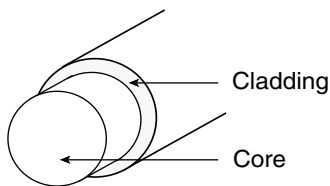

Materials Needed:

- Penlight with batteries
- Black rubber penlight boot
- 2 mm (.08 inch) diameter optical fiber, 50 cm (20 inches) long

FOLLOW THESE STEPS:

- Insert one end of the 2 mm (.08 inch) diameter fiber into the rubber boot on the penlight, then turn the penlight on.
- Take the penlight and fiber into a dark room and point the fiber end at a nearby wall.
- Grip the middle portion of the fiber in your fist so you enclose several inches of its length. Has the light coming out of the fiber's tip decreased, increased, or stayed the same in intensity? How does this compare to what happened when you gripped the 3 mm diameter plastic rod? Turn the penlight off.

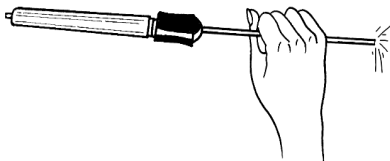

RESULTS:

Light should be visible exiting the end of the 2 mm fiber as soon as the penlight is turned on. Gripping the fiber with your hand has no effect on the light intensity emerging from the fiber end. (Moving the fiber around in the rubber boot may vary the fiber end's output intensity.)

WHY:

Light is transmitted from one end of the fiber to the other because light is being guided by the central fiber core and trapped inside by the outer cladding layer. Light intensity doesn't change when you grip the fiber in your fist because the refractive index (optical density) immediately surrounding the central core doesn't change as it did in previous experiments. The cladding layer remains constant and acts as an optical shield between the fiber core and the optical density of your hand.

FIBER OPTIC FACTS:

The fiber you just finished experimenting with is made of plastic. It is one of the two most commonly used materials in commercial optical fibers. The other material is glass — commonly called "silica" in the technical community.

5

Testing the Fiber Cladding

A fiber's cladding will protect the core even underwater

Earlier, when we immersed our U-shaped plastic rod, nearly all of the light which we sent into the rod from the penlight escaped into the surrounding water. Now let's see what happens when we use fiber with a permanent outer layer of cladding around the central light-carrying core.

Materials Needed:

- Penlight with batteries
- Black rubber penlight boot
- 2 mm (.08 inch) diameter optical fiber, 50 cm (20 inches) long
- Pan of water about 20 cm (8 inches) wide and 5 cm (2 inches) deep*

* Not contained in this kit.

FOLLOW THESE STEPS:

- Turn the penlight on. (Insert one end of the unjacketed 2 mm fiber into the rubber penlight boot if you had removed it.)
- Dim the room lights. Place as much of the fiber's middle portion in the water as possible, but be careful to keep the penlight and rubber boot out of the water.
- As you immerse the fiber, observe the amount of light coming out the end of the fiber.
- Bend the mid-section of 2 mm fiber into a "U-shape" similar to the acrylic rod and immerse it in the pan of water.
- Again observe the fiber as light travels down its length while immersed in water. Can you see any light escaping from the fiber? Where?

RESULTS:

This fiber does an excellent job of transmitting light through the total length of the fiber, even when under water. The light intensity at the far end of the fiber does not change when the midsection is immersed in water. (This confirms the value of good cladding. It ensures that light which enters one end reaches the other end virtually at the same intensity, even in unusual circumstances.)

If you see a very small amount of light on the bottom of the pan it is due to light leaking out between the fiber and rubber boot.

WHY:

Light does not escape from the central core because the boundary layer, or the cladding around the optical core, does not change when the fiber is immersed in water. Similar to when you gripped the fiber in your fist, the cladding provides an optical barrier to outside influences.

FIBER OPTIC TRIVIA:

Before fiber optics, when someone spoke into a telephone, their voice was converted to electricity by a microphone. This converted electrical signal was sent via wires to another telephone. There the electrical signal was converted by a speaker back into sound waves that the person on the other end could hear. In all long-distance conversations over fiber optics, your voice is still converted into electronics signals, but furthermore they are converted to optical (light) form for transmission. On the receiving end, optical signals are converted to electrical signals and then to sound waves.

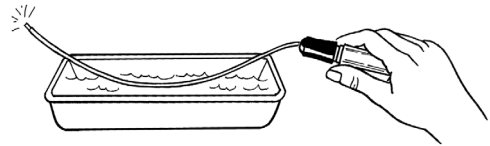

6 Tyndall's Prestigious Experiment

The first demonstration of the basic fiber optic principle

In 1870, before members of the prestigious British Royal Society, John Tyndall showed how a light beam could be guided in an arcing stream of water. Tyndall shined a bright light into a horizontal pipe leading out of a tank of water. Then, when the water was allowed to flow out and downward in an arc, light rays traveled inside the water until they were broken up by the water striking a collection pan. With the help of fiber optics you will duplicate this historical experiment.

Materials Needed:

- Penlight with batteries
- Black rubber penlight boot
- 2 mm (.08 inch) diameter optical fiber, 50 cm (20 inches) long
- Empty 1-gallon plastic milk container*
- Scissors*
- Ball point pen*
- Water*

* Not contained in this kit.

FOLLOW THESE STEPS:

- Using a scissors, cut a hole in the milk container opposite the handle, large enough to insert your hand.
- With a ball point pen puncture a hole about 3 mm (1/8 inch) in diameter in the milk container below the handle, opposite the opening you cut, approximately 2.5 cm (1 inch) from the bottom.
- Turn the penlight on. (Insert one end of the unjacketed 2 mm fiber into the rubber penlight boot if you had removed it.)
- Take the milk carton, penlight and optical fiber to your kitchen or bathroom sink. Dim the lighting in the room as much as possible while still having enough light to see.
- Fill the milk container with water while holding your finger over the hole made by the ball point pen, so no water can escape.
- Position the milk container at the edge of the sink so the puncture hole is over the basin while continuing to cover the puncture hole with your finger.
- With your other hand insert the 2 mm fiber through the opening that you cut in the milk container, and into the puncture hole. Remove your other finger.
- Observe the light beam after it leaves the fiber end and stream of water. Do you see the light in the water stream?

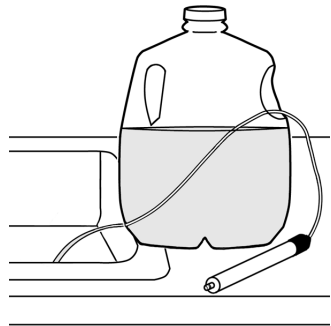

1174

RESULTS:

The light will leave the 2 mm optical fiber and follow, or be guided, by the stream of water to the bottom of the sink.

WHY:

The light is guided by water, just as light was guided in the previous experiment, because air has a lower refractive index than water, which traps light inside of it.

HISTORICAL TRIVIA:

Tyndall knew light was trapped temporarily inside the stream of water, but he could not explain why. Today, using a combination of mathematics and science, the explanation is very straight forward. Tyndall's work is significant because it marks the first recorded confirmation of the scientific principle which forms the basis of all fiber optic products today.

7

Special Optical Effects

Unusual effects can be created by modifying optical fiber

In this activity we will experiment with an optical fiber to create special visual effects. You can use these effects later in some of the projects which follow our experiments, or for projects that you may design on your own. These special effects and procedures should be used only with plastic optical fiber.

Materials Needed:

- Penlight with batteries
- Black rubber penlight boot
- 2 mm (.08 inches) diameter optical fiber, 50 cm (20 inches) long
- Single-edge razor blade or sharp knife*
- Soldering iron, alcohol lamp, Bunsen burner or propane torch*
- Blow dryer*
- Hot glue gun or clear silicone glue in a tube*
- Aluminum foil*

* Not contained in this kit.

SPECIAL EFFECTS:

These effects will be most impressive if viewed in a darkened room. First modify the fiber as instructed below, then insert one end of the fiber in the penlight boot and turn the light on.

- #1 To increase the angles of light exiting the optical fiber, turn on your heat source and slowly move the end of the fiber toward the heat until the fiber begins to melt, and forms a small ball at the tip.
- #2 Cutting the fiber end at an angle with a sharp knife or razor blade will make light emerge from the fiber at an angle.
- #3 If you coil the fiber around a spool, then heat it with a blow dryer, when cooled it will retain a coiled shape.
- #4 To create tiny sparkling points of light on your plastic fiber to enhance light effects, lightly create very small nicks in the fiber's cladding with razor blade or sharp knife. To create a "line of light," scrape along the length of the fiber.
- #5 To reflect the light coming out of the fiber end and back into it (and to make the entire fiber length more visible), place a small drop of hot glue (or silicone) on the fiber tip and attach a small piece of aluminum foil to the glue while it's still hot. (If using silicone, wait several hours for it to harden.)
- #6 To make a right-angle bend in the fiber, hold the fiber in one hand using thumb and forefinger to form a 4 cm (1.5 inches) arc. Apply heat at the point where you wish the angle to be formed. When the plastic becomes very flexible, bend the fiber into the shape you want, remove the heat source and let the fiber cool.

RESULTS:

Creating a mini-ball at the fiber tip will make the light leaving the fiber visible over a greater viewing angle. Each time you nicked and scrapped off the fiber's cladding, a small amount of light escapes at those points. Heating the optical fiber and allowing it to cool when positioned in a particular shape results in the fiber assuming that shape.

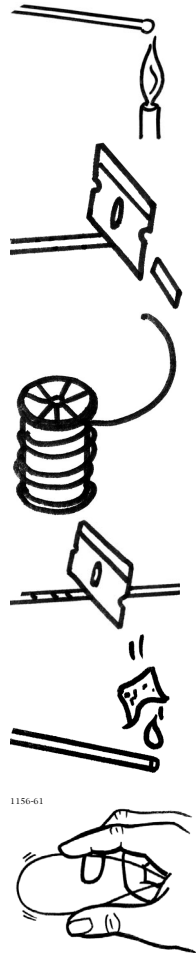

8

Optical Fiber is Tough Stuff

Flexible as Copper Wire — And Stronger

In the previous experiment you saw how easy it was to scratch the fiber's cladding. When that occurred, light was free to escape. In the commercial world, a fiber's optical cladding is protected from damage by adding another outer layer called the jacket. The fiber you will use in this experiment has a .6 mm (.024 inches) thick black polyethylene jacket covering a 980 μm diameter combined core and 10 μm cladding. We will now see how very durable and strong this fiber is.

Materials Needed:

- Penlight with batteries
- Black rubber penlight boot
- 2.2 mm (.088 inches) outside diameter jacketed fiber, .75 meter (30 inches) long
- Pan of water about 20 cm (8 inches) wide and 5 cm (2 inches) deep*
- Hammer*

* Not contained in this kit.

FOLLOW THESE STEPS:

- Insert one end of the 2.2 mm jacketed optical fiber into the hole in the penlight boot, and turn the penlight on.
- Wind the remainder of the fiber clockwise in fairly tight 5-cm (2-inch) diameter loops. (It may help to wind the fiber around a cylindrical object such as a glass, wooden dowel, or the inner cardboard tube from a roll of paper towels.)
- Observe the light intensity emerging from the fiber end as the fiber is wound.
- Unwind the fiber, then re-wind it, counter clock-wise, again observing the light coming from the fiber end.
- Insert the jacketed optical fiber into the pan of water as you did in earlier experiments and observe the light coming out from the other end. Remove the fiber from the water.
- Lay the fiber on a flat surface such as a table, and strike the mid-section of the fiber moderately hard with a hammer. As you do this, observe the amount of light coming out of the fiber.
- Turn off the penlight and remove the optical fiber from the rubber boot. Grasping one end of the fiber in each hand, tug the fiber in opposite directions in an attempt to break it.

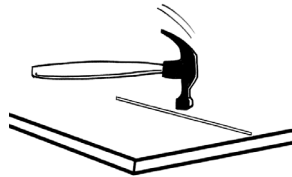

1142



1162

RESULTS:

Winding the optical fiber in coils has no effect on the light output, no matter which direction it is wound. Coiling and uncoiling the fiber multiple times doesn't stress it enough to break it (as can happen with copper wire). Placing the fiber in water has no effect on light transmission, either. Striking the fiber with a hammer has no effect on the output light intensity unless we hit it extremely hard. Trying to break the fiber by tugging on it also showed you how tough it is. (Unless you are a very strong person or damaged the fiber with the hammer, you probably could not break the fiber.)

FIBER OPTIC FACTS

It should now be obvious with fiber's strength and durability how it can successfully be bent around corners, pulled through conduits in tall buildings and installed in tight spots such as the control panels of automobiles and aircraft.

9

A Rock Called Ulexite

Nature's version of a fiber optic product

Long before any of us were on this earth, Nature was creating its own fiber optic product. It is called Ulexite, or the "TV rock."

Materials Needed:

Ulexite (off-white, irregular-shaped rock)

FOLLOW THESE STEPS:

- Place the Ulexite flat over the print on this page and observe the top surface of the crystal.
- Move the rock over an area of several square inches on the page. What do you see? Now move your head so you're observing the rock's top surface from an angle off to one side. How does the image change?
- Notice the areas of cloudiness or darkness in some parts of the crystal.
- Pick up the Ulexite and examine its sides. You can see that it actually consists of thousands of tiny fibers side by side.

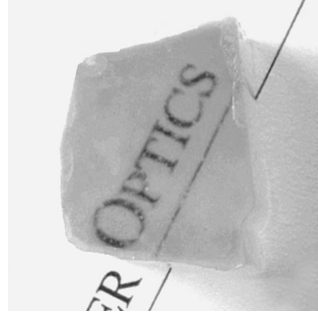

RESULTS:

You should have seen an image of printed text from the page appearing to be transferred from underneath the stone to its top surface. As you move your head from directly above the stone to one side, the location of the image doesn't change. The image will appear as it does at the top surface of the rock. You will not be able to see any images through the side of the stone.

WHY:

The Ulexite rock is composed of thousands of tiny transparent filaments that are all parallel to each other. Each filament transmits one tiny portion (a dot) of the image from one side of the stone to the other.

ULEXITE FACTS:

Our "TV rock" Ulexite is a mineral composed of chains of sodium, water and hydroxide octahedrons (figures with eight plane surfaces) linked in endless chains. These chains form the fibrous structure that transmits an image from one side of the rock to the other. The scientific name for the mineral is hydrated sodium calcium borate ($\text{NaCaB}_5\text{O}_6(\text{OH})_6 \cdot \text{H}_2\text{O}$).

Ulexite is found in Nature with the mineral borax and is directly deposited in arid regions when water evaporates from intermittent lakes called playas. Playas form only during the rainy season due to runoff (in this case, from nearby boron-rich mountains).

Boron is very water-soluble, and builds up in heavy concentrations in the playas during the runoff and evaporation cycles. Ulexite is found in California and Nevada, USA; Tarapaca, Chile; and Kazakhstan, in the former Soviet Union. The sample in this kit came from Borax, California.

Ulexite at this time is considered a low-grade boron source ore with no commercial use. As the richer boron ore in mines is depleted, Ulexite may one day be refined and used commercially. For now, it's used mostly as a mineral specimen, and in fun fiber optic experiments.

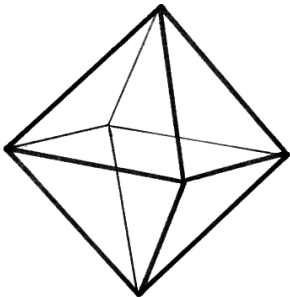

10

Fiber Faceplates

Modern technology creates a better image

Earlier, you observed how thousands of parallel filaments transferred an image from one side of the Ulexite to the other. Now it's time to take a closer look at man's improvements on Nature's multiple-fiber product.

Materials Needed:

- 10 × 10 × 2.5 mm (.4 × .4 × .10 inch) glass-like material
- 25 × 25 × 6 mm (1 × 1 × .25 inch) piece of material

FOLLOW THESE STEPS:

- Lay both items side by side on this printed page. (If either material has an opaque protective sheet on its sides, remove it.)
- Move each piece over several square inches of printed material while looking down from the top, and then at an angle.
- Determine which material has image-transferring properties like Ulexite. How would you compare the image transferring properties (the visual clarity) of the man-made material to Ulexite used in the previous experiment?
- How is the image different (if at all) than the one you observed when using the Ulexite crystal?
- Turn each element on one of its narrow sides and see if you can observe an image of the printed material through the side.

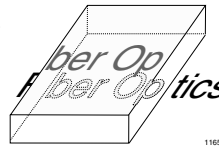
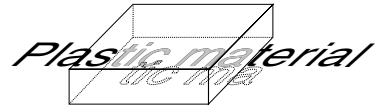

RESULTS:

After completing the steps above, you should have determined that the larger piece of material has no image-transferring properties, while the smaller and thinner piece does. The larger piece is actually just common acrylic plastic. The thinner material is a man-made material composed of thousands of tiny glass optical fibers that function like the octahedron links in Ulexite. However, the image-transferring properties of the manufactured element are far superior to those of Ulexite. There are no cloudy or dark spots across its surface, and it does not have the yellowish haze of Ulexite. When you turn the plastic piece on edge, it will appear transparent, just as when you look down through its broader surface. An image will not be visible through the sides.

FIBER OPTIC FACTS:

For a group of fibers to transmit an image from one side to the other, all the fibers must be parallel to each other. Fiber bundles that transmit images such as you have seen in this experiment are variously called coherent bundles, image conduits, or image guides. (Fiber optic elements whose width and length are greater than their depth are often called faceplates — and that definition fits the image-transferring element we used in this experiment.) Fiber bundles which have non-parallel fibers and do not transmit the original "arranged" form are referred to as "non-coherent elements."

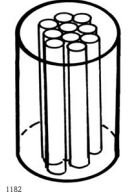
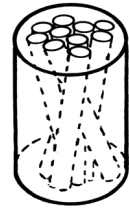

11 Making Your Own Image Conduit

Coherent image conduits can contain thousands of fibers

In this experiment you will construct a coherent fiber optic bundle from individual fibers that you cut to length, fasten together and polish. Then you'll see how your craftsmanship stacks up against other fiber arrays or bundles.

Materials Needed:

- 10 .5 mm (.02 inch) diameter plastic optical fibers, 1 meter (39.4 inches) long
- 9.5 mm (3/8 inch) diameter black heat shrink tubing, 2.5 cm (1 inch) long
- 2000 grit polishing paper (dark gray color)
- 3 μ m polishing film (pink color)
- Single-edge razor blade or sharp knife*
- Blow dryer*
- Toenail clippers*
- Water, light oil or glycerin*
- Paper towels*

* Not contained in this kit.

FOLLOW THESE STEPS:

- Using a sharp knife or razor blade, cut all the .5 mm (.02 inch) diameter fibers into 30 mm (1.25 inch) lengths.
- Insert all of the 30 mm lengths into the 9.5 mm heat shrink tubing, keeping the fibers straight and as parallel to each other as possible.
- Try to get all of the fiber tips flush with each other on one end. It may help to grip the heat shrink lightly and tap the fiber ends on a flat surface so they are all about even.
- Use the blow dryer to carefully heat the heat shrink tubing so it contracts and holds the fibers in place. Apply hot air evenly and from all directions.
- Use the toenail clippers to cut the fibers on both ends so their tips are as even as possible.
- Place the 2000 grit polishing paper on a flat firm surface and wet it with water, light oil or glycerin. Hold the fiber bundle upright, at right angles to the polishing paper, and polish it with a gentle figure-8 pattern as shown above. Continue polishing until both fiber bundle ends are flat.
- Wet the 3 μ m polishing film with water or light oil and again polish both fiber bundle ends. Dry the bundle ends with paper towels.
- Place one end of your newly created fiber bundle over the text on this page, starting with the larger print sizes and moving to smaller print.

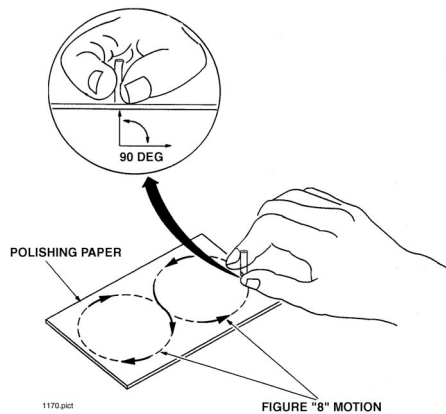

RESULTS:

The fiber bundle that you just made should exhibit the same "image-transferring" properties as the Ulexite and the faceplate used in the previous experiments. Some fibers may appear dark.

WHY:

The fiber bundle just assembled will not have as high a resolution (detail) as the Ulexite or man-made faceplate. The bundle transferred the image from one side to the other because most of the fibers were all parallel to each other inside the heat shrink. The reason some of the fibers appear dark is that they may be broken internally, or they were not even with the other fibers at one end or the other.

12

Fiber Optics and Lenses

Together they form an interesting and imaging combination

You may have asked yourself, "What good is a piece of material composed of thousands of optical fibers?" Why not just look through a piece of glass or plastic? In this experiment you will see how fiber optics can be combined with lenses to focus an image that can be viewed at all angles...and solve a difficult problem that we encounter if we use regular lenses.

Materials Needed:

- Ulexite (off-white, irregular-shaped rock)
- $10 \times 10 \times 2.5$ mm (.4 \times .4 \times .1 inch) fiber optic faceplate
- $25 \times 25 \times 6$ mm (1 \times 1 \times .25 inch) piece of plastic
- Lens, double convex, approximately 25.4 mm (1 inch) diameter
- Piece of white paper

FOLLOW THESE STEPS:

- Find a room with one or more windows. Turn off the lights and shut all window coverings except one.
- Hold the lens up in one hand and with your other hand hold the piece of paper behind the lens. Turn your back to the window so light is coming in over your shoulder. The flat surfaces of the window, paper and lens should all be parallel to each other. Hold the lens approximately 4 to 5 cm (1.6 to 2 inches) away from the paper. Focus the image of the scene outside the window on it by moving the lens either closer or further away from the paper to focus the image as clearly as possible. (The distance from the lens to the paper is slightly longer than the *focal length* of the lens.)
- This time you will be facing the window and holding the lens and Ulexite in front of you. Replace the paper with the Ulexite and position the lens about the same distance from the Ulexite that you found to best focus the image in the previous step. Is the image you see on the surface of the Ulexite upright or inverted?
- Replace the Ulexite with the fiber optic faceplate. What are the differences between the images you see through the Ulexite and the faceplate?
- Replace the fiber optic faceplate with the 25×25 mm (1 \times 1) piece of plastic. Can you see the same image on the plastic as you did with the Ulexite and faceplate?

RESULTS:

The lens should focus the image (or scenery) from the window onto the white paper with a separation of 4 to 5 cm (1.6 to 2 inches). The image will appear upside down (inverted). The image formed by the lens onto the Ulexite will not be visible from the lens side and only visible from the opposite side. The image viewable on the Ulexite will be inverted and the same size as it was when imaged onto the paper. The image formed by the lens onto the faceplate will be identical in size and shape as the image seen on the Ulexite, only clearer and without the yellowish tint. No viewable image can be seen on either side of the plastic piece, due to the lens.



1180



1171

13

The Art of Polishing Glass

It is much easier than you think, but it does take patience

Have you ever wondered how lenses in telescopes, cameras and eyeglasses are made? First, a glass block is ground to a predetermined lens shape with a grinding stone. Then the surface of the glass is polished in a series of steps with special grinding or polishing compounds. This technique may sound crude and antiquated, but it works very well. Lenses can be made with a surface roughness thousands of times finer than the width of a human hair. In this experiment you will use similar methods to "fine tune" a glass fiber bundle that was cut with a rough blade.

Materials Needed:

- 3 mm diameter \times 4.3 cm ($1/8 \times 1-3/4$ inch) image conduit (glass-like rod)
- 2000 grit polishing paper (dark gray color)
- 3 μ m polishing film (pink color)
- Water, light oil or glycerin*
- Paper towels*

* Not contained in this kit.

FOLLOW THESE STEPS:

- Place the 3 mm ($1/8$ inch) image conduit over the text on this page and observe the image present on the top end. (The image will likely be very poor.)
- Now look closely at both end surfaces of the image conduit. They may be very rough and have visible grooves across both faces.
- Place the 2000 grit polishing paper on a flat firm surface and wet with water, light oil or glycerin. Hold the image conduit upright, at right angles to the polishing paper, and polish it with a gentle figure-8 pattern as in **Experiment 11**. Continue polishing until both ends have all the rough spots removed.
- View the text on this page through the image conduit.
- Place the 3 μ m polishing film on a flat firm surface and wet with water, light oil or glycerin. Again polish both fiber bundle ends with the same figure-8 patterns until both ends are flat and shiny. Dry the bundle ends with a paper towel.
- Now view the printed text on this page through the image conduit.



RESULTS:

The light guide will transmit images before polishing, but because both ends are rough, the image quality may be poor. After the rough edges were removed by polishing with the 2000 grit paper, the image quality improved, and further improved when polished with the 3 μ m film.

WHY:

The image guide does not transmit a good image when the ends are rough because the end placed against the text does not make complete contact with the paper. Also, if the viewing end is not polished, the light that is transmitted through it scatters over a wide angle.

SCIENTIFIC TRIVIA:

No one knows when and where glass was first made. The first object crafted entirely of glass were beads from Mesopotamia and ancient Egypt, dating from about 2500 B.C. Small glass vessels painstakingly sculpted from solid blocks of glass are estimated to be about 4000 years old. In the latter first century B.C., probably in Syria, the technique of glassblowing was developed. From the eighth to eleventh century, a glass of outstanding technical and artistic quality was made in what are now Iran, Iraq and Egypt. A flourishing glass industry did not develop in Europe until the end of the thirteenth century, when Venice became a major glassmaking center. Venetians provided the link between ancient and modern glassmaking arts and developed the technique for making clear glass.

14 Visual Clarity Comes in Bundles

To achieve high-quality images, very small fibers are required

In the previous experiments you will have noticed that the images through the different fiber optic imaging elements appeared different. Two items determine how an image appears through a fiber bundle — resolution and transmission. Resolution is determined by how small the fiber diameters are. See for yourself.

Materials Needed:

- Ulexite (off-white, irregular-shaped rock)
- 2.5 cm (1 inch) long fiber bundle (constructed in **Experiment 11**)
- 10 × 10 × 2.5 mm (.4 × .4 × .1 inch) fiber optic faceplate
- 3 mm diameter × 4.3 cm (1/8 × 1-3/4 inch) image conduit (glass-like rod)

FOLLOW THESE STEPS:

- Place the Ulexite, fiber bundle, faceplate and image conduit over one column of letters shown at the right.
- Slowly move all the items down each letter, moving from larger to smaller letters.
- Determine which of the fiber optic elements produces the best image (highest resolution) of the smaller letters.

K	K	K
V	V	V
R	R	R
P	P	P
G	G	G

RESULTS:

You should have found that the fiber optic faceplate produces the clearest images with the small letters. The 3 cm (1/8 inch) diameter image conduit has less resolution than the faceplate, but more than the Ulexite. The Ulexite image also is yellowish and has cloudy or dark spots in it. The 2.5 cm long bundle that you constructed in a previous experiment would have the poorest resolution of all tested items.

WHY:

The image quality transmitted by each of the bundles is directly related to the size of fiber from which it is made. Smaller diameter equals better resolution. The fiber optic faceplate, made with fibers 10 μm (.0004 inch) in diameter, has the highest resolution. The 3 mm diameter image conduit has 50 μm diameter fibers and is the next best. The Ulexite does not have actual fibers, but rather small crystals that vary in cross-section. We can not specify a dimension, but estimate them to be slightly larger than the 50 μm diameter found in the 5 cm length of image conduit. The image through the Ulexite has a yellowish cast due to the sodium in it. The poorest resolution is found with the fiber bundle you constructed in Experiment 11 using the .5 mm fibers.

SCIENTIFIC TRIVIA:

Randomly arranged fibers can be bundled together like spaghetti, but imaging bundles take considerably more care. They are made in a series of phases. First a fiber is selected that is about 2.5 mm (.1 inch) in diameter. A group of these fibers is bundled together, heated and shrunk into rigid "multifiber" bundles about 2 mm (.08 inch) in diameter. Then several multifibers bundles are packed together, heated and shrunk to produce a rigid bundle containing thousands of fibers. The individual fibers can vary from 3 to 20 μm in diameter.

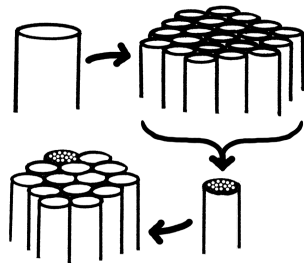

1143

15

Fiber Does the Bends

Sand (silica) melts to form glass at approximately 2000°C

The 3 mm (1/8 inch) diameter image conduit used in previous experiments is made of glass. As you know, glass can be formed into many different shapes. Windows are flat, bowls and dishes are curved, and more complex shapes are used in the test tubes and flasks found in a chemical laboratory. We will show you how to change the shape of this glass image conduit to illustrate one of the important capabilities of coherent image guides.

Materials Needed:

- 3 mm diameter \times 4.3 cm (1/8 \times 1-3/4 inch) image conduit (glass-like rod)
- 2 small binding clips
- Isopropyl alcohol*
- Paper towels*
- Cotton gloves or two pads of cloth*
- Alcohol lamp, Bunsen burner or propane torch*

* Not contained in this kit.

FOLLOW THESE STEPS:

- Clean the image conduit with isopropyl alcohol and a paper towel. Attach a paper binding clip to each end of the image conduit. Light your heat source and let its heat stabilize. Make sure it rests on a steady surface. Put on gloves or have two pads of cloth handy.
- Hold the image conduit, using the binding clips, with gloved hands or pads of cloth. Position the conduit's mid-section at the very tip of the blue flame for about 30 seconds. Remove from the heat and let cool for five minutes. Remove binding clips and see if the image conduit kept its image transmission properties by placing either end over the printed text on this page and viewing from the top.
- Place the binding clips again onto the image conduit and back into the flame while turning it slowly. Continue heating the mid-section until it starts to soften. Using both pads and light pressure, bend the conduit 45 degrees from vertical as shown in the figure. Turn off the heat source and let the conduit cool for five minutes.
- Place one end of the image conduit over the text on this page while looking into the other end. Move the conduit to different letters on this page. Has bending changed its image-transferring properties?

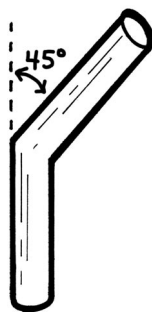

1145

RESULTS:

Heating the center of the image conduit until it grew hot, then letting it cool, did not affect its image transmission properties, nor did heating and bending it at an angle. After the light guide was bent it transferred an image just as it did when straight. The experiment shows that fiber bundles will transmit images through bends and around corners.

WHY:

The fiber optic light guide is composed of thousands of individual glass fibers. Each fiber consists of a central light-carrying portion and outer cladding. Heating the image guide does not melt the core and cladding together (which would make it lose its image-transferring properties). The heat only makes it flexible enough to form into a new shape.

SCIENTIFIC TRIVIA:

The addition of various metallic compounds can produce different colors in glass. Addition of Cobalt oxide produces blue glass. Green glass is obtained by adding chromium or iron compounds. Red glass is produced by adding cadmium, cuprous oxide, or gold. In the making of optical fiber, manufacturers strive the reverse: they try to remove as many impurities as possible.

16 Fiber Optic Image "Inverters"

Image conduit produces inverted images

As you've seen in the previous experiment, heating and bending the fiber optic conduit did not affect its image-transferring ability. In this experiment you will further heat and modify the shape of the image conduit to show you another one of its unique properties.

Materials Needed:

- 3 mm diameter \times 4.3 cm ($1/8 \times 1-3/4$ inch) image conduit (glass-like rod)
- 2 Paper binding clips
- Isopropyl alcohol*
- Paper towels*
- Alcohol lamp, Bunsen burner or propane torch*
- Cotton gloves or two pads of cloth*

* Not contained in this kit.

FOLLOW THESE STEPS:

- Clean the image conduit with a paper towel and isopropyl alcohol. Attach a paper binding clip to each end of the conduit. Light your heat source and let its flame stabilize. Put on cotton gloves, or have two pads of cloth close at hand.
- Place the image conduit into the flame holding the paper binding clips with gloved hands or pads of cloth. Heat the mid-section in the top of the flame until it starts to soften, then straighten the conduit to remove the bend.
- While still applying heat, twist the conduit so that one end is 180 degrees (one half rotation) from its original position. Very little force should be needed or used to twist the conduit. Turn off the heat and let the conduit cool for five minutes.
- Examine the letters to the right of this paragraph through the image guide. What has happened to the image at the end of the conduit? Do the letters through the conduit appear upside down? When you move the image conduit to the right, which direction does the image appear to move across the viewing end of the image guide?

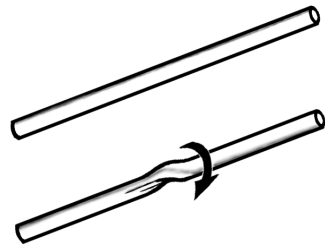

1175

I	I
N	M
V	A
E	G
R	E

RESULTS:

By heating the image guide and twisting it 180 degrees, you turned the conduit into what is commonly known as a fiber optic image inverter. Everything at the viewing of the image conduit appears to be inverted, or rotated it 180 degrees, from the image on the page. (Think of the twists in a candy cane.)

WHY:

As mentioned before, heating the fiber optic image guide didn't affect its image-transferring capability, but it did raise the temperature of the fibers until they became flexible enough to twist. After heating and twisting it 180 degrees, a single fiber strand at one location on a conduit end will be moved to an "upside down" position at the other end.

BRAIN TEASER:

Based on what you learned here and in an earlier experiment, how could you use heat and a fiber optic image conduit to make a product that would enlarge or reduce the images that you see on the opposite end?

17

Flexible Fiber Bundles

Fiber optics was first used for communications in 1976

In previous experiments you worked with short fiber optic bundles that transmitted a coherent image. We used a short length only as a matter for your convenience. One of fiber optics' greatest benefits is its ability to function over very long distances. The 3 mm diameter coherent rod you experimented with previously was originally 1.2 meters (48 inches) long, from the manufacturer. In this experiment you are going to construct a much longer bundle, which will also be flexible.

Materials Needed:

- Penlight with batteries
- 25 .25 mm (.01 inches) unjacketed optical fibers, 1 m (39.4 inches) long
- 5 mm (3/16 inch) diameter white heat shrink tubing, 7.5 cm (3 inches) long
- Rubber bands (3)
- Single-edge razor blade or sharp knife*
- Blow dryer*

* Not contained in this kit.

FOLLOW THESE STEPS:

- Using a sharp knife or razor blade, cut all the .25 mm (.01 inch) diameter fibers into 30 cm (9 inch) lengths.
- Insert all of the .25 mm fibers in the heat shrink tubing. Arrange the fibers so about 1.5 cm (3/8 inch) of the fiber ends sticks out beyond one end of the heat shrink, and fibers are flush with each other. Hold fibers in place with the rubber bands.
- Once all the fibers are in place, heat the shrink tubing with a blow dryer to contract the tubing. Use heat sparingly to avoid damaging fibers.
- Trim both ends of the fiber so they are all the same length, using a razor blade or sharp knife.
- Turn the penlight on. (Remove the rubber boot if it is installed.) Hold the bulb end of the penlight against the exposed tips at either end of the fiber bundle and observe the light coming out the other end.
- Bend the fiber bundle while holding one end to the penlight's bulb.
- Point either end of the fiber bundle toward the sun while flexing the bundle.
- Place either fiber end over the text on this page while viewing the tips at the other end.

RESULTS:

The fiber bundle that you assembled is flexible and will readily transmit light from one end to the other when one end is pointed at the penlight bulb. No changes in light intensity should occur as you bend the bundle, provided you keep the fiber tips and penlight in the same positions. Light from the sun will also travel from one end to the other, and will not vary as you move the bundle. This bundle will not transmit an image of the text because the fibers are not precisely aligned with each other on both ends, although as you move the bundle across the text you may notice some fibers going from white to black. This collection of optical fibers is flexible, but it is an incoherent bundle.



FIBER OPTIC FACTS:

As you may have seen in the news, an important use of fiber optics is for telephone communications. In telephone applications its long distance capability is being widely used to transmit large amounts of information. Fiber systems have been laid across the Pacific and Atlantic oceans. A link already in operation stretches from Long Island, New York, to Lands End, Britain, to Penmarch, France.

18

More Fiber and Lenses

Lenses can focus images onto — and from — fiber bundles

In previous experiments we used a lens to focus images on the surface of a fiber optic faceplate and Ulexite. In this activity you will demonstrate how a lens can also be used in reverse, focusing an image of fiber(s) and projecting the light from fiber ends.

Materials Needed:

- Penlight with batteries
- Black rubber penlight boot
- 2.2 mm (.088 inch) outside diameter jacketed optical fiber, .75 m (30 inches) long
- Lens, double convex, approximately 25.4 mm (1 inch) diameter
- Multifiber light guide constructed in **Experiment 17**
- Masking tape*

* Not contained in this kit.

FOLLOW THESE STEPS:

- Insert one end of the 2.2 mm (.088 inch) outside diameter jacketed optical fiber into the hole in the rubber boot and turn the penlight on.
- Turn off room lights and close all the window coverings. Leave one door open so you can see your way around.
- Stand about 1 meter (40 inches) away from a wall. Hold the fiber and penlight in one hand and the lens in the other, about 4 to 5 cm (1.6 to 2 inches) away from the fiber end, as shown in the illustration. Move the lens closer to the fiber end, then further away, and observe the effect that the separation distance has on the focused light which appears on the wall.
- Replace the jacketed optical fiber in the penlight boot with the multifiber light guide that you constructed in Experiment 17. Insert the end closest to the heat shrink into the rubber boot.
- Arrange the individual fibers in a crescent shape as shown in the illustration, with all fiber ends flush with each other. Hold the fibers in position with masking tape.
- Starting with the lens 4 to 5 cm (1.6 to 2 inches) away from the illuminated fiber tips, project light through the lens and onto the wall. Observe the shape of the image produced on the wall.

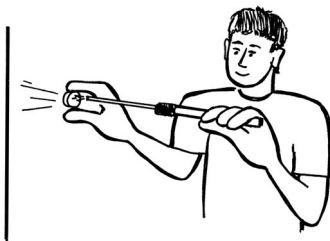

RESULTS:

When the distance between the fiber ends and the lens is slightly longer than the focal point of the lens, light leaving the fiber ends will form an image on the wall. The shape of the image that the lens produces will correspond to the shape of the fiber ends. The jacketed optical fiber and multifiber bundle will produce round and crescent shapes, respectively. (In the crescent shape, you may be able to see light from individual fibers.)

WHY:

The lens collects the light exiting each fiber and focuses or images it to some point in space because of its focusing capability. The distance between the lens and the fibers where the image is focused best will be just slightly longer than the focal length of the lens. The image formed on the wall doesn't depend on the shape of the light leaving the fibers. It depends on the shape of the fiber where the light exits.

Understanding light at the very smallest level — atomic

An atom consists of a small and dense nucleus, surrounded by electrons — the same particles that produce electric currents. Electrons circle the nucleus at difference distances. The farther they are from the nucleus, the more energy they have. If an electron moves from an outer orbit to a closer one, it loses energy. This energy is released as a particle of light called a "photon." In most atoms there are many electrons and many different energy levels. The color of light that each electron can produce depends on how much energy the electron loses while falling from one orbit to an other.

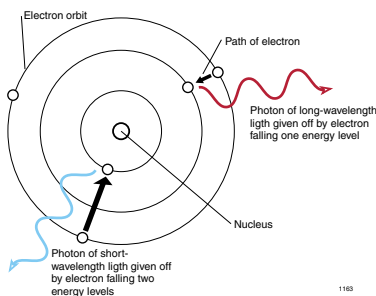
**Materials Needed:**

- Red-colored 1 mm (.04 inch) diameter optical fiber
- Green-colored 1 mm (.04 inch) diameter optical fiber
- 3 mm (1/8 inch) black heat shrink tubing, 15 cm (6 inches) long

FOLLOW THESE STEPS:

- Lay the red- and green-colored fibers on a table and observe their brightness and color, from all sides and angles. Does the fiber end appear different than the side?
- Find a room which you can completely darken. With the lights off and window coverings closed, do the green and red fibers continue to glow ("fluoresce")?
- Turn the room lights back on and open any window coverings. Insert one end of the red fiber inside the heat shrink tubing and slide the fiber slowly into it while observing the exposed fiber end. How does the brightness of the exposed fiber end change as the fiber slides into the black tubing? Repeat with the green fiber.

RESULTS:

The center portion or "core" of both colored fibers appears to "glow" as if the fibers were producing red or green light. The fibers' sides are uniform in color, but dull. As the room light diminishes, the glow from the fiber ends decreases. In a totally dark room the fiber will stop glowing. As the fibers are inserted into the heat shrink tubing the glow from the exposed end does not change at first. When the fiber exposed from the tubing is 5 cm (2 inches) or less, the brightness appearing from the fiber end begins to decrease. When the fiber is surrounded by the walls of the heat shrink, the fiber end will be very dim.

WHY:

In this special fiber material, atoms absorb light of one color, and almost immediately release the energy as light of another color. Many substances fluoresce when ultraviolet light strikes them. We can not actually see ultraviolet, but we can see the lower-energy light that fluorescence produces.

The red- and green-colored fiber contains a central core which includes a material with fluorescent properties. The fluorescent core absorbs blue and ultra-violet light from all directions. Having absorbed energy, it radiates this energy in the form of red or green light (depending on the material in its core). The cladding on the outside of the fiber core traps the radiated light and guides it toward the ends, which is why they glow and the sides do not.

APPLICATIONS:

These types of fibers are often used in radiation protection and measuring devices. The fluorescent material absorbs high-energy alpha, beta and gamma radiation and converts that energy into forms measurable by conventional light detectors.

20

Molecular Structures

Optical fibers, although very pure, are not crystals

A crystal is commonly considered a solid object with flat sides and sharp corners in a symmetrical arrangement. One example is rock salt, which has an atomic structure as shown. Such materials always break cleanly along specific lines and patterns like diamonds or rubies. Now we will experiment to learn about the structure of Ulexite, glass and plastic fiber.

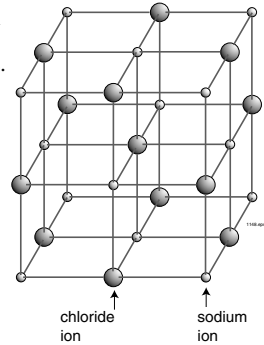

Materials Needed:

- Ulexite
- 2 mm unjacketed optical fiber, 50 cm (20 inches) long
- 3 mm diameter \times 4.3 cm ($1/8 \times 3/4$ inch) image conduit (glass-looking rod)
- Three-sided file (a small emery board for fingernails will also work)*
- Pliers*

* Not contained in this kit.

FOLLOW THESE STEPS:

- Scratch a nick in the cladding of the plastic fiber about 12 mm (.5 inches) from one end with one of the file's (emery board) corners.
- Select a spot near one end of the image conduit where the fiber bundle is not twisted and scratch it with the file in the same manner.
- Scratch a line on one of the Ulexite's flat viewing surfaces with the one of the file's corners.
- Position the plastic fiber on a table so the nick faces up, and the nick portion slightly extended from the table edge. Press down firmly on the main part of the fiber with one hand (close to the nick) and grip the end of the short half-inch section with thumb and forefinger of your other hand. Now break off the short piece as you would break a cracker.
- In the same fashion, break the shorter piece off the glass image guide.
- Grip the Ulexite squarely with a pair of pliers on one side of the scratch. Grasp the other side with thumb and forefinger, then snap the Ulexite apart.
- Examine the new broken or cut edges of the Ulexite, plastic fiber and image guide .



1176

RESULTS:

The end of the plastic fiber is rough and jagged as compared to a nearly clean break on the image conduit. The Ulexite breaks off along the filed edge.

WHY:

Glass and plastic are both "amorphous" materials — which means they lack crystalline form. Materials like these do not break along straight edges like jewels. The glass image guide produced a very clean flat break over most of its surface, the way a crystal might break, except near the end. It breaks like a crystal because glass has a very simple molecular structure that behaves nearly like that of a crystal once a weak point has been made. Plastic, on the other hand, is composed of very long and complex molecular chains. Their random and long molecular structure produces very rough breaks.

The Ulexite breaks along its fibrous crystal edges. The broken surface may not be perfectly smooth, but you will see that the break is always along the long fibrous or crystalline links. The Ulexite mineral will not readily break in any other direction.

1

Create a Fiber Optic Wand

Merlin Would Have Been Proud Of You

You now have 20 different fiber optics experiments to your credit. From this point, we move on to projects in which you will create lasting fiber optics devices that you can use to impress your fellow students, parents, grandparents and friends.

Materials Needed:

- Penlight with batteries
- Black rubber penlight boot
- Multifiber light guide which you constructed in **Experiment 17**
- Single-edge razor blade or sharp knife*
- Alcohol lamp, Bunsen burner or propane torch*

* Not contained in this kit.

FOLLOW THESE STEPS:

- With the rubber boot removed from the penlight, insert the multifiber light guide end closest to the heat shrink through the hole on the rounded side of the boot until the fibers extend 2 cm (3/4 inch) beyond the flat base of the boot.
- Turn on your heat source and carefully heat the fiber ends extending through the rubber boot until they melt together just slightly. Turn off the heat source and let the fiber ends cool about 5 minutes.
- Pull the fiber ends back through the hole in the rubber boot until they extend only about 1 cm (3/8 inch) into the boot.
- Fit the rubber boot over the penlight and turn the light on.
- Dim the room lights and close all window coverings. (You may also go outside if it's nighttime.) Observe the light going through the fibers and exiting the fiber ends. Shake or move the penlight about.
- To change the colors of light coming from the fiber ends, remove the rubber boot and cut red, green, or blue plastic filter material to fit inside the rubber boot. To make a multicolor wand, use several colors and experiment with different positions.
- After you have completed **Project #4**, you can apply some of the techniques that you learned in **Experiment #7** to make your *light wand* reflect your personal designs.



1177

2

Lighting the Stars

Your personal fiber optic "constellation"

Optical fibers are often used in displays to create or enhance special posters or maps. Now you will see how fiber optics can add visual effects to a map of the stars.

Materials Needed:

- Penlight with batteries
- Black rubber penlight boot
- Multifiber light guide which you constructed in **Experiment 17**
- Star and constellation map
- 20 cm × 20 cm (8 × 8 inch) Foamcor® mount
- Twist ties
- Needle*
- Pencil or large nail*
- Hot glue gun and glue (or clear silicone)*
- Single-edge razor blade or sharp knife

* Not contained in this kit.

FOLLOW THESE STEPS:

- * The star map has a pattern representing the stars and constellations in the earth's northern hemisphere. Each small dot is the location of a star. Select no more than 100 stars that you wish to illuminate in this project.
- Remove the backing from the constellation map and center it on the Foamcor® board.
- With a needle, punch a hole in the map at each dot, large enough for the 250 μm (.010 inch) fiber to go through.
- If using a hot glue gun, turn it on now.
- Place the multifiber fiber bundle on the back side of the map. From the rear, insert one fiber at a time into the holes punched in the map. Insert each fiber until its tip is flush with the front of the cardboard. Adhere in place with the glue gun (or silicone).
- Repeat, inserting a fiber into map for every star. (You will have fibers left over.)
- Insert the fiber bundle into the rubber boot until the ends extend about 1 cm (3/8 inch) inside.
- Fit the rubber boot over the penlight.
- Punch holes in the lower portions of the map marked with an "X" using a pencil or large nail.
- Position the penlight behind the four holes in the map and fasten it in place with the twist ties provided.
- Cut a 16 cm (6 inch) length of the jacketed optical fiber, using a single-edge razor blade or sharp knife. Glue the fiber to the back of the star map as shown. This fiber will be used as a hanger for your map.
- Turn the penlight on to view your completed project.

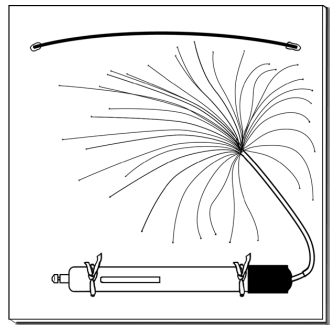

1178

3

Personal Holiday Ornament

Fluorescence will brighten up your holiday season

In this project you will use the fluorescent fibers that you experimented with previously to create your personal ornament for the holiday season. If you would like to make more of these ornaments, please see the back of this manual for ordering information.

Materials Needed:

- 1.0 mm⁺ (.04 inch) red fluorescent fiber, 15 cm (6 inches) long
- 1.0 mm⁺ (.04 inch) green fluorescent fiber, 15 cm (6 inches) long
- Holiday wreath
- Single-edge razor blade or sharp knife*
- Safety glasses or goggles*
- Alcohol lamp, Bunsen burner or propane torch*
- Pliers*
- Super Glue®*

* Not contained in this kit

† Other sizes and colors may be substituted in the kit for more variety in ornaments.

FOLLOW THESE STEPS:

- Put on safety glasses or goggles .
- Cut all the fluorescent fibers into 1 cm (.4 inch) lengths with a single-edge razor blade or sharp knife. Try to get as clean a cut as possible.
- Place your heat source on a firm flat surface. Light the fuel with a match and adjust the flame until it burns steadily.
- Use the pliers to hold the ends of the individual fibers to "flame polish" the ends to a smooth, slightly rounded surface by holding them in the flame.
- Count the number of fiber lengths you have. Each small fluorescent fiber length will simulate a light on your miniature fiber optic tree ornament.
- Decide which side you want to be the wreath's front.
- Insert each fiber perpendicularly into the wreath with the flame-polished end flush with the front side of the wreath. Super Glue® in place if you wish. Use alternate colors during insertion,
- Attach an ornament hook to the top of the wreath if its not already attached.

An Example of a Large Detector for the SSC
Showing the Locations of the Various Components

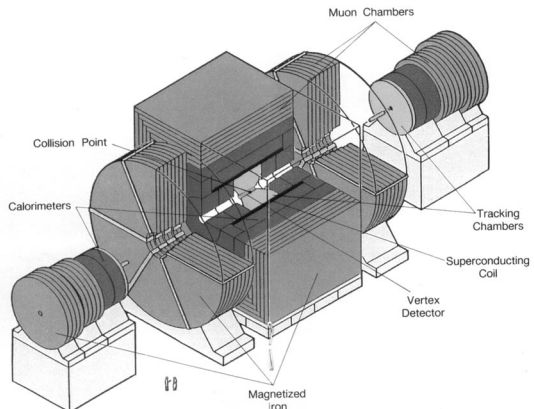

Shown above is a diagram of a detector used high physics experiments. Fluorescent fiber is used in the calorimeter for detecting certain atom particles.

4 Putting Your Name in Lights

You are just one step away from being in show business

This project utilizes the fiber optic bundle which you assembled in **Experiment 17**, and later used in **Project 1** and **2**. This time you will create a fiber optic display which will project the initials of your name on the wall of a darkened room.

Materials Needed:

- Penlight with batteries
- Black rubber boot
- Lens, double convex, approximately 25.4 mm (1 inch) diameter
- 2.5 cm (1 inch) diameter acrylic cylinder, 10 cm (4 inches) long
- 2.22 cm (7/8 inch) diameter acrylic cylinder, 5 cm (2 inches) long
- Multifiber bundle constructed in **Experiment 17**
- Cardboard circle 22 mm (7/8 inch) diameter*
- Pin (the type used in sewing)*
- Pencil*
- Super glue*

* Not contained in this kit.

FOLLOW THESE STEPS:

- Cut a circle 2.22 cm in diameter from cardboard.
- Print your initials in the center of the cardboard. Each letter should be about 6 mm (.25 inch) in diameter.
- Using the sewing pin, poke holes through the cardboard, following the shape of your initials. Try to space them 1 mm (.04 inches) apart or closer, and keep the pin perpendicular so the pattern of your initials is accurately copied to the other side of the cardboard.
- Insert a fiber from your multifiber bundle into each hole on the side marked with your initials (back). Position the fibers so they stick out slightly on the other side (about 0.5 mm or .02 inches) and are fairly even with each other.
- Apply Super Glue[®] glue sparingly to the back of the cardboard (where you printed your initials) to hold fibers in place, and let the glue dry.
- Pull the portion of the fiber bundle with the heat shrink through the smaller diameter acrylic tube until the cardboard contacts the cylinder end. Center the cardboard to the acrylic cylinder and secure with Super Glue[®].
- If you want your initials to be projected in color, glue any of the colored film (included in the kit) over the fiber ends sticking through the front of the cardboard.
- Place three small balls of hot glue (or silicone) on either end of the larger acrylic cylinder, then attach the lens to cylinder end, centering to each other. Set aside to let the glue (silicone) dry.
- Insert the front of the fiber array into the acrylic cylinder until it is about 5 cm away from the lens.
- Insert the free end of the fiber bundle into the hole in the boot. Install the rubber boot on the penlight.
- Turn the penlight on and dim the room lights.
- Position yourself and the acrylic cylinder about 1.5 meters (5 feet) from a wall. Point the acrylic cylinder toward the wall and slide the cardboard back and forth in the acrylic tube until your initials are in sharp focus on the wall.

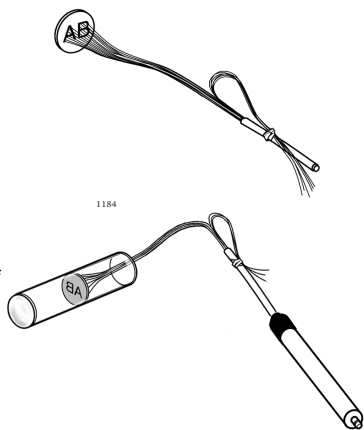

5 Fiber Optic Image Magnifier

Sometimes, common items have intriguing properties

In this project you will use a simple round plastic ball which can act like a lens. This effect can be used with an image conduit to produce a fiber optic product that will magnify images.

Materials Needed:

- 3 mm diameter \times 2.5 cm ($1/8 \times 1$ inch) image conduit (glass-like rod)
- 12 mm ($1/2$ inch) diameter clear plastic ball
- Hot glue gun and glue (or clear silicone)*
- Isopropyl alcohol*
- Cotton swabs*

* Not contained in this kit.

FOLLOW THESE STEPS:

- If using a hot glue gun, turn it on now. Clean one end of the image conduit with a cotton swab and alcohol.
- Place a small ball of hot glue (or clear silicone) on the cleaned end of the conduit. Quickly place the plastic ball onto the glue and glass rod so it looks as shown here. Set the ball/conduit aside for the adhesive to cool (or wait several hours for silicone to harden).
- Once the adhesive has hardened, place the flat end of the image conduit over the printed text on this page. Move the end of the guide over the surface of the page while observing the image which appears through the glass ball. How is the image different than the one you saw in Experiment 13, using the image guide without the ball attached?
- If you have a very clear marble, you may also be able to use it as a lens. Remove the ball and adhesive and repeat the steps above, using the marble. (Hot glue and silicone are not permanent.)

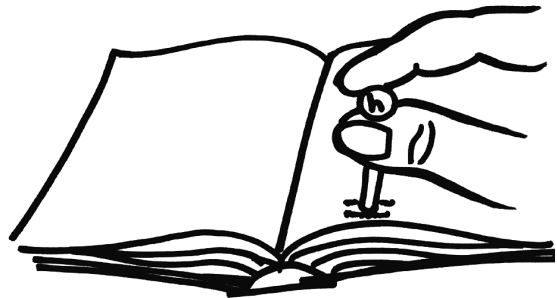
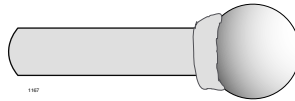

RESULTS:

When the ball is on the viewing end (top) of the image conduit, the image will appear larger than when using only the image conduit itself.

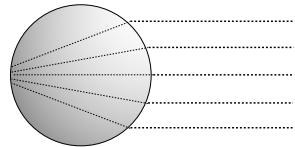

WHY:

The glass ball in this experiment acts as a lens. Attached to the image conduit, it acted as an enlarging lens. This effect is illustrated in the figure to the right.