

AVR-Based Serial Enabled LCDs Hookup Guide

Introduction

The AVR-based serial enabled LCD (a.k.a. SerLCD) is a simple and cost effective solution for adding Liquid Crystal Displays (LCDs) into your project. The PCB design on the back of the screen includes an ATmega328P that handles all of the screen control. It can accept commands via serial, I²C and SPI. This simplifies the number of wires needed and allows your project to display all kinds of text and numbers.

The firmware is fully opensource and available for download at the github repo here:

[OPENLCD FIRMWARE GITHUB REPOSITORY](#)

This allows for any customizations you may need. Uploading firmware (custom or updates), is easily done from the Arduino IDE using a Serial Basic. See firmware update instructions in the troubleshooting section of this tutorial for more info.

Also note, the example code used below is all available in the repo (along with many more examples). Before beginning this tutorial, it's a good idea to clone the repository (or download the entire repo as a zip), to grab all of the examples. But if you prefer, you can always use the "COPY CODE" button on each of the examples below.

We offer three varieties of the AVR-based Serial Enabled LCDs:



SparkFun 20x4 SerLCD - Black on RGB 3.3V
● LCD-14074



SparkFun 16x2 SerLCD - RGB on Black 3.3V
● LCD-14073



SparkFun 16x2 SerLCD - Black on RGB 3.3V

● LCD-14072

Note that these all have identical firmware and can accept the same commands. However, you must adjust your display characters and cursor position as necessary for each model. Also note, there is a jumper on the back of each screen, and this “tells” the firmware how to correctly set the lines and columns for each screen.

Required Materials

To follow along with this tutorial, you will need the following materials at a minimum. Depending on what you have, you may not need everything on this list. Add it to your cart, read through the guide, and adjust the cart as necessary.

Wishlist for AVR-based Serial Enabled LCDs Hookup Guide SparkFun Wish List



SparkFun 16x2 SerLCD - Black on RGB 3.3V
LCD-14072



Trimpot 10K with Knob
COM-09806

There are lots of trimpots out there. Some are very large, some so small they require a screwdriver. Here at SparkF...



Wall Adapter Power Supply - 5V DC 2A (Barrel Jack)
TOL-12889



This is a high quality switching 'wall wart' AC to DC 5V 2000mA Barrel Jack wall power supply manufactured specif...



SparkFun USB Mini-B Cable - 6 Foot

CAB-11301

This is a USB 2.0 type A to Mini-B 5-pin cable. You know, the mini-B connector that usually comes with USB Hubs, ...



Arduino and Breadboard Holder

DEV-11235

We've been prototyping for a long time on these awesome little plastic plates but it's time for an upgrade. This versi...



Breadboard - Self-Adhesive (White)

PRT-12002

This is your tried and true white solderless breadboard. It has 2 power buses, 10 columns, and 30 rows - a total of ...



Jumper Wires Standard 7" M/M - 30 AWG (30 Pack)

PRT-11026

If you need to knock up a quick prototype there's nothing like having a pile of jumper wires to speed things up, and ...



Break Away Headers - Straight

PRT-00116

A row of headers - break to fit. 40 pins that can be cut to any size. Used with custom PCBs or general custom head...



SparkFun Logic Level Converter - Bi-Directional

BOB-12009

If you've ever tried to connect a 3.3V device to a 5V system, you know what a challenge it can be. The SparkFun bi...



SparkFun RedBoard - Programmed with Arduino

DEV-13975

At SparkFun we use many Arduinos and we're always looking for the simplest, most stable one. Each board is a bit...

Tools

You may need a soldering iron, solder, and general soldering accessories, and screw driver depending on your setup.



Solder Lead Free - 100-gram Spool

© TOL-09325



Pocket Screwdriver Set

© TOL-12891



Weller WLC100 Soldering Station

🕒 TOL-14228

Suggested Reading

If you aren't familiar with the following concepts, we recommend checking out these tutorials before continuing.

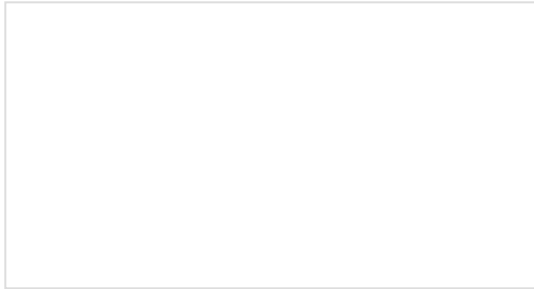

How to Solder: Through-Hole Soldering

This tutorial covers everything you need to know about through-hole soldering.

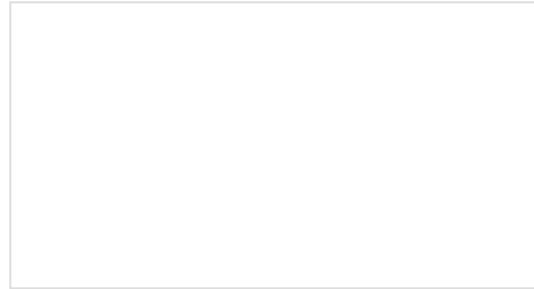

Serial Communication

Asynchronous serial communication concepts: packets, signal levels, baud rates, UARTs and more!

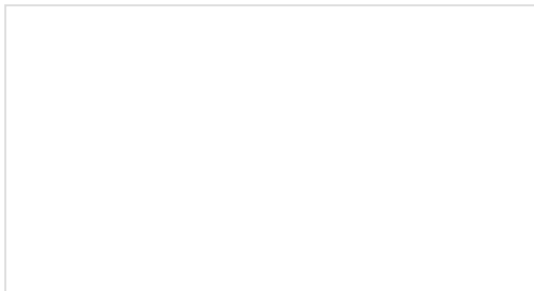

Serial Peripheral Interface (SPI)

SPI is commonly used to connect microcontrollers to peripherals such as sensors, shift registers, and SD cards.

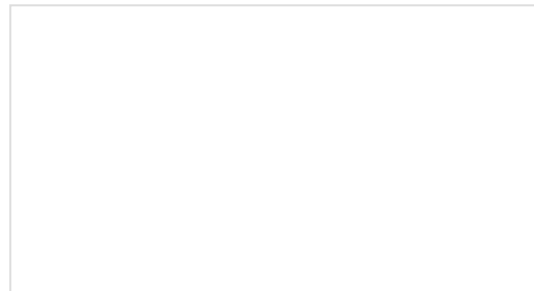

What is an Arduino?

What is this 'Arduino' thing anyway?

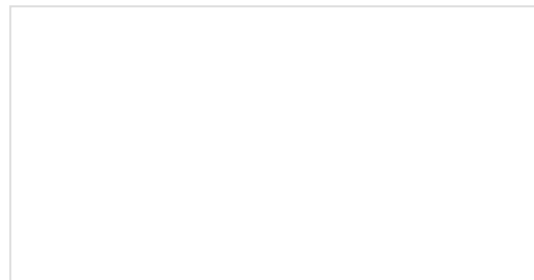
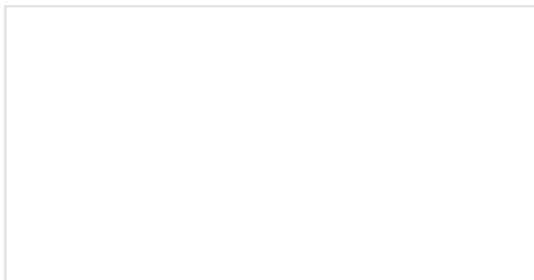

Installing Arduino IDE

A step-by-step guide to installing and testing the Arduino software on Windows, Mac, and Linux.

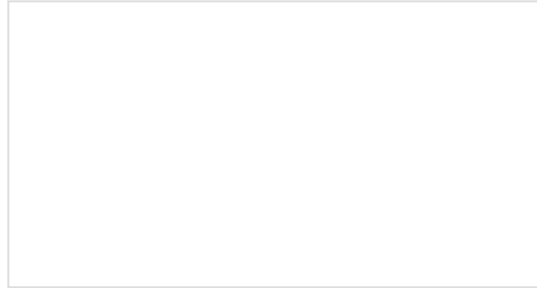

I2C

An introduction to I2C, one of the main embedded communications protocols in use today.

Logic Levels

Learn the difference between 3.3V and 5V devices and logic levels.

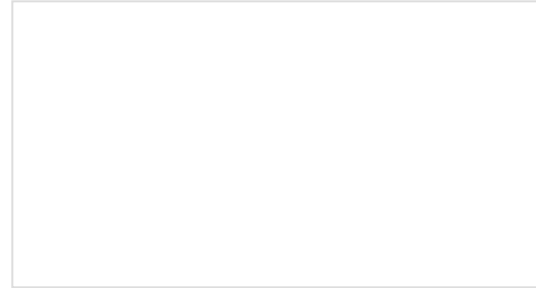

ASCII

A brief history of how ASCII came to be, how it's useful to computers, and some helpful tables to convert numbers to characters.

 **Note:** Click on any of the images in this tutorial for a closer look!

Hardware Overview

The AVR-based SerLCD has some new features that make it even more powerful and economical:

- AVR microcontroller utilizes 11.0592 MHz crystal for greater communication accuracy
 - Adjustable baud rates of 1200, 2400, 4800, **9600 (default)**, 14400, 19200, 38400, 57600, 115200, 230400, 460800, 921600, 1000000
- The AVR ATmega328p (with Arduino-compatible bootloader) is populated on the back of each LCD screen and handles all of the LCD control
- 3 communication options: Serial, I²C and SPI
- Adjustable I²C address controlled via software special commands (**0x72 default**)
- Emergency reset to factory settings (Jumper RX to GND on bootup)
- Operational backspace character
- Incoming buffer stores up to 80 characters
- Pulse width modulation of backlight allows direct control of backlight brightness and current consumption
- Pulse width modulation of contrast allows for software defined contrast amount. The previous backpack versions of this product required adjusting the contrast via a hardware trim-pot which was less precise and less accessible in most enclosed projects.
- User definable splash screen
- Open-sourced firmware and Arduino-compatible bootloader enables updates via the Arduino IDE

AVR-Based Serial Controller (3.3V logic only)

Using these screens, it is easy to connect to any microcontroller that has a serial UART, I²C, or SPI. You could also use a single board computer such as the Raspberry Pi if you wanted. Whatever you choose, **please make sure you convert to 3.3V Logic!** In our examples below, we chose to use our Redboard with a Logic Level Converter.

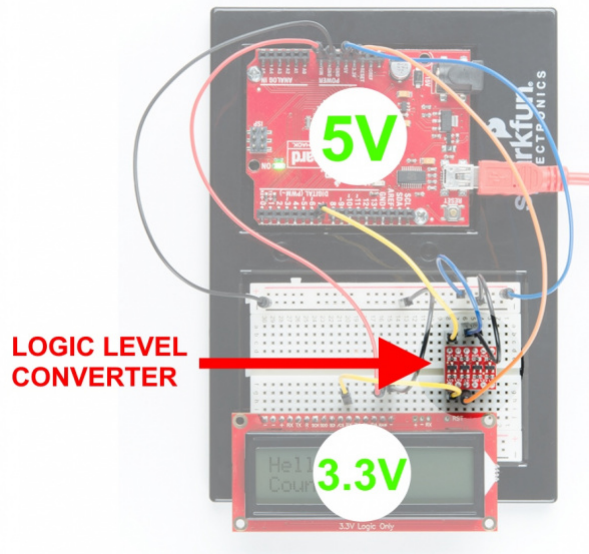

Example setup including 5V Redboard and Logic Level Converter

Connection Options

Both sizes of these screens (16x2 and 20x4) have a row of headers along the top side. This is where you can connect power and your choice of communication protocol (Serial UART, I²C, or SPI). It also has our 6-pin Arduino Serial port available for convenient firmware updates.

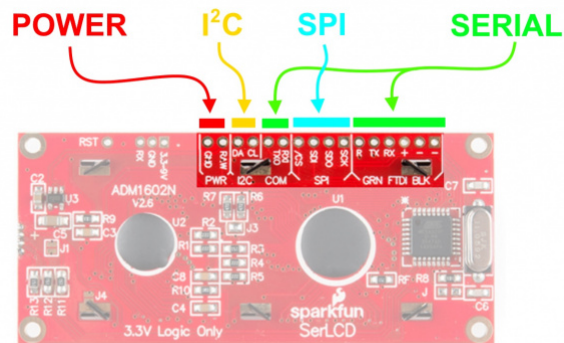

Main header pinouts

Note, if you choose Serial UART, there is a handy 3-pin JST footprint. This includes the minimum connections needed: RX, GND and VIN. Our JST Jumper 3 Wire Assembly is a good way to go:

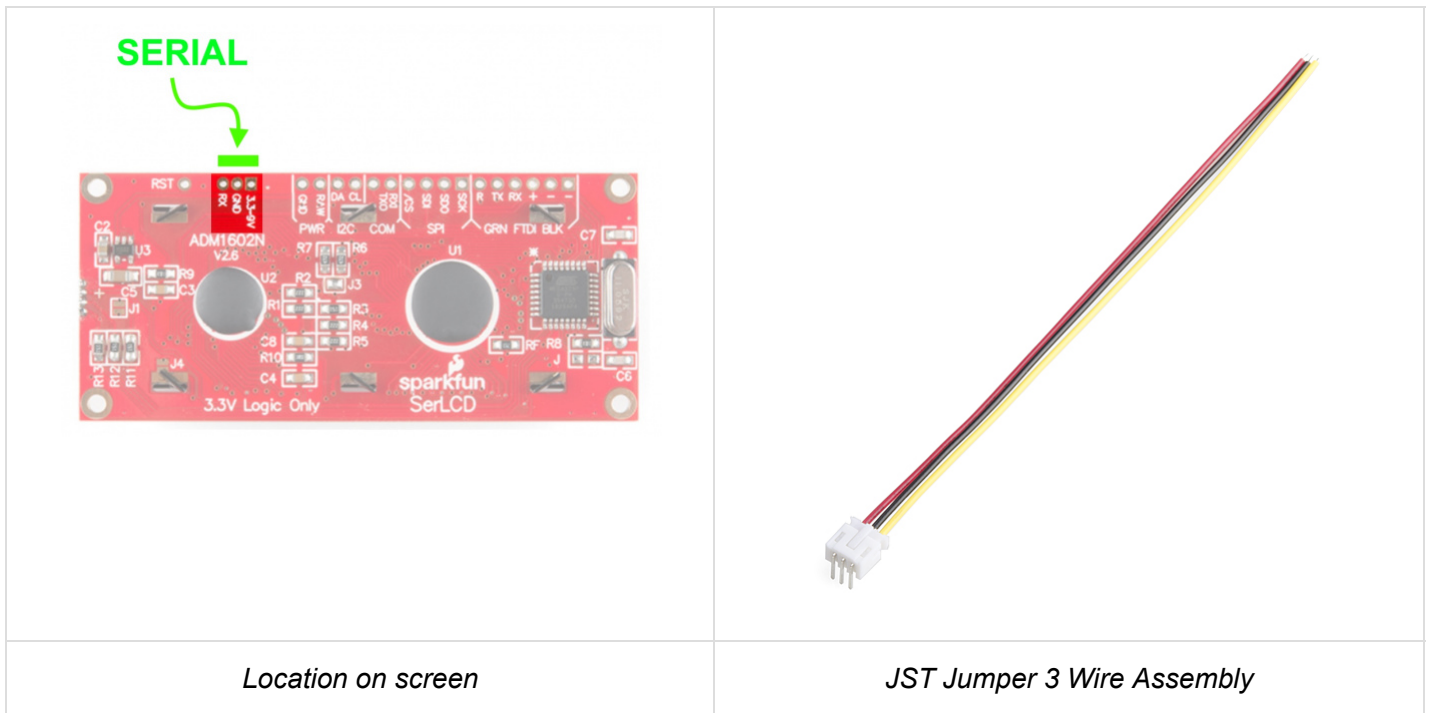

Input Voltage (VDD) and Logic Levels

All of these screens can be powered by **3.3-9V**. You have two pin options for connecting up power. One is labeled “RAW” and the other (on the 3-pin JST) is labeled “3.3-9V”. **Note, the pin labeled “+” is NOT a power input pin!** This is connected to the VCC of the ATmega329p (3.3V).

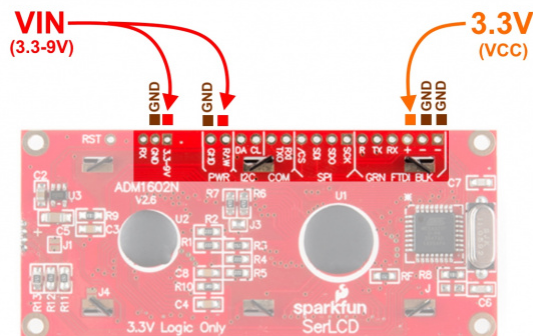

Power Input pin options and Atmega328 VCC pin

Pro tip: If you plan to run 100% brightness on all three colors (red, green, blue), then it would be best to keep your power input voltage low. As close to 3.3V as possible is best. This will keep the on-board *linear* 3.3V voltage regulator nice and cool. It can accept up to 9V and power all three backlights at 100%, but it will get a little warm, and over years of use, potentially damage the vreg. For more information about vregs and why they heat up sometimes, please check out our tutorial: [Power and Thermal Dissipation](#)

⚡ **Warning!** ONLY USE **3.3V** LOGIC LEVELS when connecting to any of the data pins on the LCD screens. Connecting directly from a 5V microcontroller (such as the Redboard) will damage your LCD screen permanently!

Contrast Control

The on-board ATmega328p controls the contrast of the screen using a PWM signal. This can be adjusted by sending a command via Serial UART, I²C, or SPI. The screens ship out with the contrast setting set to 10, which we have found works well for most environments. Temperature and supply voltage can affect the contrast of the LCD, so you may need to adjust it accordingly. For more info about contrast and a detailed example, please see the section below called: Serial UART: Example Code - Contrast Control with a Trimpot.

Hardware Hookup - Initial

Install Headers

For this tutorial, we are going to try out Serial UART, I²C, and SPI. In order to easily follow along using a breadboard, solder some headers to the connection ports along the side of your screen. Also solder some headers onto either side of the Logic Level converter. This will allow us to easily plug these into the breadboard and wire each data line up with jumper wires.

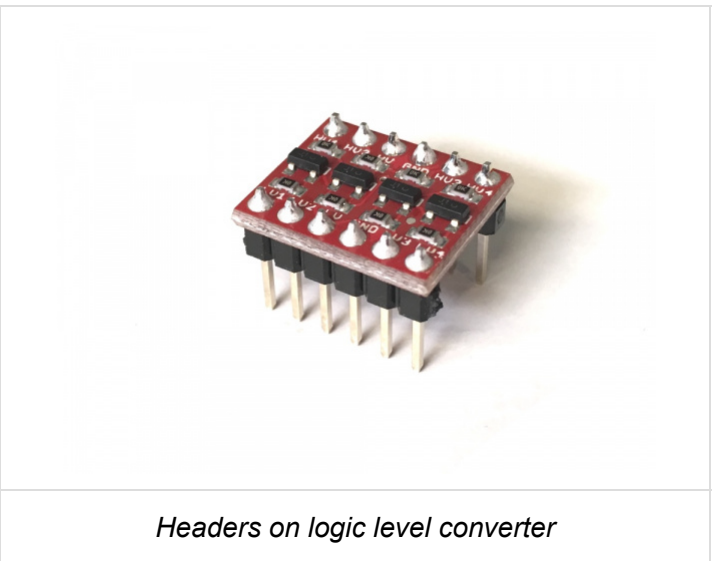
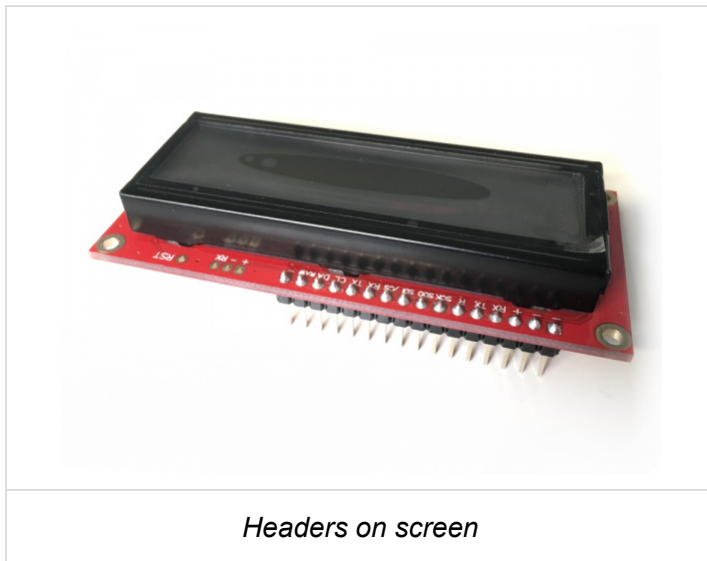

Note, we are going to use the 16x2 model with RGB backlight during this tutorial. If you are using a different model (RGB text or the 20x4), then the header pin-out and spacing is identical.

Connecting to an Arduino

⚠ Warning! Do not use the TX pin from your Arduino (aka "hardware serial TX") to control your LCD.

The TX pin is used for Serial Uploads of new sketches onto your Arduino, and will cause problems for both your Arduino and the LCD. In other words, when you upload new code to your "project" Arduino, it will be confused because the screen is sharing that TX pin. Please only use software serial to control your LCD. For all of the Serial UART examples, we have setup software serial on D7.

⚠ Warning! The RX input should be a TTL-level signal of 3.3V. If you are using a 5V Arduino, you will need a logic level converter between the two.

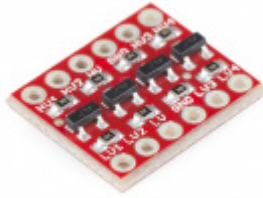

SparkFun Logic Level Converter - Bi-Directional

● BOB-12009



SparkFun Level Translator Breakout - PCA9306

○ BOB-11955



SparkFun Voltage-Level Translator Breakout - TXB0104

● BOB-11771

You should **NOT** connect the board directly to RS232-level voltages (which are around +/-10V). This will damage the board. For more information on RS232, see our explanation [here](#)). If you do wish to connect this display to RS232 signals, you can use a level-shifting board to translate the RS232 signals to TTL-level signals.



SparkFun Transceiver Breakout - MAX3232

● BOB-11189



SparkFun RS232 Shifter - SMD

○ PRT-00449



SparkFun RS232 Shifter SMD (No DB9)

● PRT-08780

For the first set of examples in this tutorial (SERIAL UART), there are three connections you need to make to the LCD: RX, GND, and RAW. For the other communication protocols that we will explore later, you will need to wire up some other lines. Please see the following Fritzing graphic to see how to wire up your connections through a logic level converter.

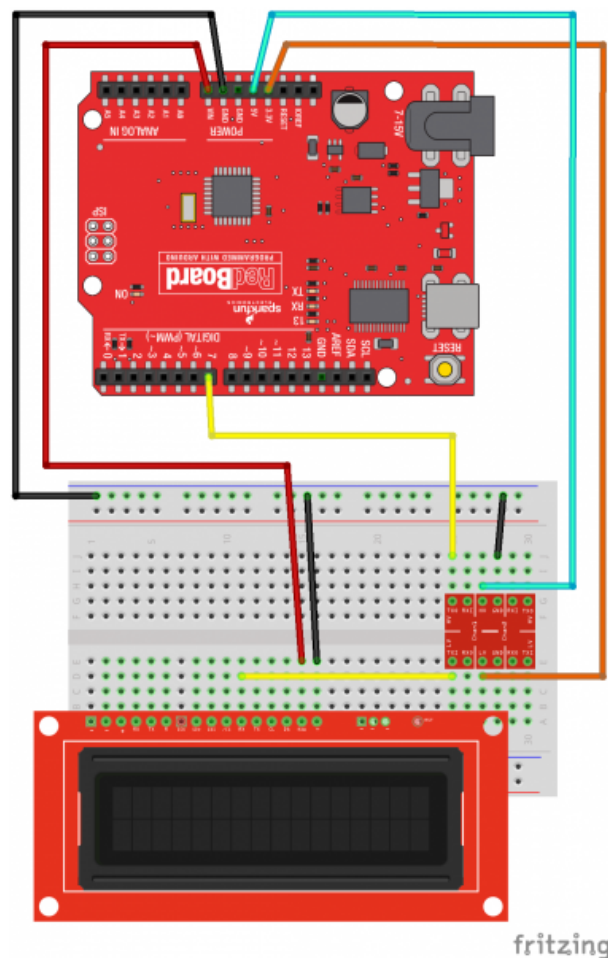

Firmware Overview

The most basic way to use these screens is to simply send characters to them. They will display on the screen as you send them, and then if you go beyond the last character of the screen, it will begin overwriting from the first spot.

You can choose to send characters over Serial UART, I²C, or SPI. The best way to learn about each communication protocol is to try out the “basic” example located in the github repository.

Note: The examples in this tutorial assume you are using the latest version of the Arduino IDE on your desktop. If this is your first time using Arduino, please review our tutorial on installing the Arduino IDE.

In addition to basic operation, there are special commands you can send the screen for special operations (like “clear screen” or set cursor position) and configuration settings (like BAUD RATE).

Configuration & Command Set

The special character for “or” (aka ‘|’) used to tell the screen to enter “settings mode”. You then follow this command with another special character (usually “ctrl+c”, ctrl+d, etc.). A complete table of commands are shown below in ASCII, DEC and HEX. Any one of these representations is acceptable when sending a command character.

The HD44780 LCD controller is very common. The extended commands for this chip include but are not limited to those described in table. Please refer to the HD44780 datasheet for more information.

Note, this “cheat sheet” is also located at the top of each example code section for easy reference.

ASCII	DEC	HEX	Description
	124	0x7C	Enter Settings Mode
ctrl+h	8	0x08	Software reset of the system
ctrl+i	9	0x09	Enable/disable splash screen
ctrl+j	10	0x0A	Save currently displayed text as splash
ctrl+k	11	0x0B	Change baud to 2400bps
ctrl+l	12	0x0C	Change baud to 4800bps
ctrl+m	13	0x0D	Change baud to 9600bps
ctrl+n	14	0x0E	Change baud to 14400bps
ctrl+o	15	0x0F	Change baud to 19200bps
ctrl+p	16	0x10	Change baud to 38400bps
ctrl+q	17	0x11	Change baud to 57600bps
ctrl+r	18	0x12	Change baud to 115200bps
ctrl+s	19	0x13	Change baud to 230400bps
ctrl+t	20	0x14	Change baud to 460800bps

ctrl+u	21	0x15	Change baud to 921600bps
ctrl+v	22	0x16	Change baud to 1000000bps
ctrl+w	23	0x17	Change baud to 1200bps
ctrl+x	24	0x18	Change the contrast. Follow Ctrl+x with number 0 to 255. 40 is default.
ctrl+y	25	0x19	Change the TWI address. Follow Ctrl+x with number 0 to 255. 114 (0x72) is default.
ctrl+z	26	0x1A	Enable/disable ignore RX pin on startup (ignore emergency reset)
'\`'	45	0x2D	Clear display. Move cursor to home position.
n/a	128- 157	0x80- 0x9D	Set the primary backlight brightness. 128 = Off, 157 = 100%.
n/a	158- 187	0x9E- 0xBB	Set the green backlight brightness. 158 = Off, 187 = 100%.
n/a	188- 217	0xBC- 0xD9	Set the blue backlight brightness. 188 = Off, 217 = 100%.

OpenLCD "Cheat Sheet" Command Set

Clear Screen and Set Cursor Position

Clear display and set cursor position are the two commands that are used frequently. To clear the screen, send the control character '|' followed by '-'. Clearing the screen resets the cursor position back to position 0 (i.e. the first character on the first line).

Here's how you could do it doing a Serial UART write on software serial:

```
OpenLCD.write('|'); //Send setting character
OpenLCD.write('-'); //Send clear display character
```

Note, most of the example sketches in the repo use these two commands during setup(), so you can try any of the examples out to see these commands in action.

To set the active cursor position, send the control character **254** followed by **128 + row + position**. To give this a shot, check out the complete example sketch in the github repo or copy and paste the following into your Arduino IDE:

```
/*
OpenLCD is an LCD with Serial/I2C/SPI interfaces.
By: Nathan Seidle
SparkFun Electronics
Date: April 19th, 2015
License: This code is public domain but you buy me a beer if you use this and we meet someday
(Beerware license).

OpenLCD gives the user multiple interfaces (serial, I2C, and SPI) to control an LCD. SerLCD was
the original
serial LCD from SparkFun that ran on the PIC 16F88 with only a serial interface and limited fea
ture set.
This is an updated serial LCD.

This example shows how to change the position of the cursor. This is very important as this is
the
fastest way to update the screen, ie - rather than clearing the display and re-transmitting a h
andful of bytes
a cursor move allows us to re-paint only what we need to update.

We assume the module is currently at default 9600bps.

We use software serial because if OpenLCD is attached to an Arduino's hardware serial port duri
ng bootloading
it can cause problems for both devices.

Note: If OpenLCD gets into an unknown state or you otherwise can't communicate with it send 18
(0x12 or ctrl+r)
at 9600 baud while the splash screen is active and the unit will reset to 9600 baud.

Emergency reset: If you get OpenLCD stuck into an unknown baud rate, unknown I2C address, etc,
there is a
safety mechanism built-in. Tie the RX pin to ground and power up OpenLCD. You should see the sp
lash screen
then "System reset Power cycle me" and the backlight will begin to blink. Now power down OpenLC
D and remove
the RX/GND jumper. OpenLCD is now reset to 9600bps with a I2C address of 0x72. Note: This featu
re can be
disabled if necessary. See *Ignore Emergency Reset* for more information.

To get this code to work, attached an OpenLCD to an Arduino Uno using the following pins:
RX (OpenLCD) to Pin 7 (Arduino)
VIN to 5V
GND to GND

Command cheat sheet:
ASCII / DEC / HEX
'|' / 124 / 0x7C - Put into setting mode

Ctrl+c / 3 / 0x03 - Change width to 20
Ctrl+d / 4 / 0x04 - Change width to 16
Ctrl+e / 5 / 0x05 - Change lines to 4
Ctrl+f / 6 / 0x06 - Change lines to 2
Ctrl+g / 7 / 0x07 - Change lines to 1
```

Ctrl+h / 8 / 0x08 - Software reset of the system
 Ctrl+i / 9 / 0x09 - Enable/disable splash screen
 Ctrl+j / 10 / 0x0A - Save currently displayed text as splash
 Ctrl+k / 11 / 0x0B - Change baud to 2400bps
 Ctrl+l / 12 / 0x0C - Change baud to 4800bps
 Ctrl+m / 13 / 0x0D - Change baud to 9600bps
 Ctrl+n / 14 / 0x0E - Change baud to 14400bps
 Ctrl+o / 15 / 0x0F - Change baud to 19200bps
 Ctrl+p / 16 / 0x10 - Change baud to 38400bps
 Ctrl+q / 17 / 0x11 - Change baud to 57600bps
 Ctrl+r / 18 / 0x12 - Change baud to 115200bps
 Ctrl+s / 19 / 0x13 - Change baud to 230400bps
 Ctrl+t / 20 / 0x14 - Change baud to 460800bps
 Ctrl+u / 21 / 0x15 - Change baud to 921600bps
 Ctrl+v / 22 / 0x16 - Change baud to 1000000bps
 Ctrl+w / 23 / 0x17 - Change baud to 1200bps
 Ctrl+x / 24 / 0x18 - Change the contrast. Follow Ctrl+x with number 0 to 255. 120 is default.
 Ctrl+y / 25 / 0x19 - Change the TWI address. Follow Ctrl+x with number 0 to 255. 114 (0x72) is default.
 Ctrl+z / 26 / 0x1A - Enable/disable ignore RX pin on startup (ignore emergency reset)
 '-' / 45 / 0x2D - Clear display. Move cursor to home position.
 / 128-157 / 0x80-0x9D - Set the primary backlight brightness. 128 = Off, 157 = 100%.
 / 158-187 / 0x9E-0xBB - Set the green backlight brightness. 158 = Off, 187 = 100%.
 / 188-217 / 0xBC-0xD9 - Set the blue backlight brightness. 188 = Off, 217 = 100%.

For example, to change the baud rate to 115200 send 124 followed by 18.

*/

```
#include <SoftwareSerial.h>
```

```
SoftwareSerial OpenLCD(6, 7); //RX (not used), TX
```

```
int counter = 250;
```

```
void setup()
```

```
{
  Serial.begin(9600); //Start serial communication at 9600 for debug statements
  Serial.println("OpenLCD Example Code");

  OpenLCD.begin(115200); //Begin communication with OpenLCD

  //Send the reset command to the display - this forces the cursor to return to the beginning of
  the display
  OpenLCD.write('|'); //Send setting character
  OpenLCD.write('-'); //Send clear display character

  OpenLCD.print("Hello World!   Counter: "); //For 16x2 LCDs
  //OpenLCD.print("Hello World!           Counter: "); //For 20x4 LCDs
}
```

```
void loop()
```

```
{
  OpenLCD.write(254); //Send command character
}
```

```

    OpenLCD.write(128 + 64 + 9); //Change the position (128) of the cursor to 2nd row (64), position 9 (9)

    OpenLCD.print(counter++); //Re-print the counter
    //OpenLCD.print(" "); //When the counter wraps back to 0 it leaves artifacts on the display

    delay(2); //Hang out for a bit if we are running at 115200bps
}

```

The two lines of code that are actually changing the cursor position are as follows:

```

OpenLCD.write(254); //Send command character
OpenLCD.write(128 + 64 + 9); //Change the position (128) of the cursor to 2nd row (64), position 9 (9)

```

The example sets the cursor to the second row, position 9. To set the cursor to the first row, position 0, the command would look like this:

```

OpenLCD.write(254); //Send command character
OpenLCD.write(128 + 0 + 0); //Change the position (128) of the cursor to 1st row (0), position 0 (0)

```

Use the following tables to see row commands and available positions:

16 Character Displays	
Line Number (command)	Viewable Cursor Positions
1 (0)	0-15
2 (64)	0-15

20 Character Displays	
Line Number (command)	Viewable Cursor Positions
1 (0)	0-19
2 (64)	0-19
3 (20)	0-19
4 (84)	0-19

Setting Up the LCD Size

You should never need to send any screen size configuration commands to setup these screens. During *setup()*, the firmware looks at a specific pin that is either left floating or tied high. From this it can determine which screen size it is populated on (16x2 or 20x4). However, the commands are still available for manually setting the width and lines.

ASCII	DEC	HEX	Description
	124	0x7C	Enter Settings Mode
ctrl+c	3	0x03	Change width to 20
ctrl+d	4	0x04	Change width to 16
ctrl+e	5	0x05	Change lines to 4
ctrl+f	6	0x06	Change lines to 2
ctrl+g	7	0x07	Change lines to 1

Changing the Baud Rate

The screens ship out with a default baud rate setting to **9600 baud**, but they can be set to a variety of baud rates. The 11.0592 MHz crystal provides greater clock accuracy and allows for baud rates up to 1MHz!

To change the baud rate, you will need to send two commands: First, send the “|” command to enter settings mode. Second, send the desired baud rate command. (For example, to set it to 57600, you’d send | , then ctrl+q)

⚠ Caution! Once you change the baud rate, you need to change the baud rate of your controlling device to match this. To change the LCD's baud rate from 9600 to 57600, first enter the control character **0x7C** control and **0x11**. Then adjust your microcontroller's code to match the baud rate of 57600.

Here is a table with all of the available baud rate settings commands:

ASCII	DEC	HEX	Description
	124	0x7C	Enter Settings Mode
ctrl+k	11	0x0B	Change baud to 2400bps
ctrl+l	12	0x0C	Change baud to 4800bps
ctrl+m	13	0x0D	Change baud to 9600bps
ctrl+n	14	0x0E	Change baud to 14400bps
ctrl+o	15	0x0F	Change baud to 19200bps
ctrl+p	16	0x10	Change baud to 38400bps
ctrl+q	17	0x11	Change baud to 57600bps
ctrl+r	18	0x12	Change baud to 115200bps
ctrl+s	19	0x13	Change baud to 230400bps

ctrl+t	20	0x14	Change baud to 460800bps
ctrl+u	21	0x15	Change baud to 921600bps
ctrl+v	22	0x16	Change baud to 1000000bps

OpenLCD Baud Rate Command Set

If your screen enters into an unknown state or you otherwise can't communicate with it, try sending a Ctrl + r (**0x12**) character at 9600 baud while the splash screen is active (during the first 500 ms of boot-up) and the unit will reset to 9600 baud.

Backlight Brightness

These screens provide you with control of the backlight to one of 30 different brightness levels on each of the colors (Red, Green and Blue). With this, you can mix colors together to get almost any custom color you'd like. This is also handy when power consumption of the unit must be minimized. By reducing the brightness, the overall backlight current consumption is reduced.

Note: The LCD screens that have RGB text on black background, the control of the "backlight" is actually controlling the RGB values of the text brightness.

To change the backlight brightness, you will need to send two commands: First, send the "]" command to enter settings mode. Second, send a number that corresponds to the color and brightness you'd like to set. (For example, to set the Green backlight to 100%, you'd send | , then 187). For some good example code on how to adjust any and all of the colors, check out the example sketch here or copy and paste the code below into your Arduino IDE:

```
/*
OpenLCD is an LCD with serial/I2C/SPI interfaces.
By: Nathan Seidle
SparkFun Electronics
Date: April 19th, 2015
License: This code is public domain but you buy me a beer if you use this and we meet someday
(Beerware license).
OpenLCD gives the user multiple interfaces (serial, I2C, and SPI) to control an LCD. SerLCD was
the original
serial LCD from SparkFun that ran on the PIC 16F88 with only a serial interface and limited fea
ture set.
This is an updated serial LCD.
```

This example shows how to change the backlight brightness. We assume the module is currently at default 9600bps.

We use software serial because if OpenLCD is attached to an Arduino's hardware serial port during bootloading

it can cause problems for both devices.

Note: If OpenLCD gets into an unknown state or you otherwise can't communicate with it send 18 (0x12 or ctrl+r)

at 9600 baud while the splash screen is active and the unit will reset to 9600 baud.

Emergency reset: If you get OpenLCD stuck into an unknown baud rate, unknown I2C address, etc, there is a

safety mechanism built-in. Tie the RX pin to ground and power up OpenLCD. You should see the splash screen

then "System reset Power cycle me" and the backlight will begin to blink. Now power down OpenLCD and remove

the RX/GND jumper. OpenLCD is now reset to 9600bps with a I2C address of 0x72. Note: This feature can be

disabled if necessary. See *Ignore Emergency Reset* for more information.

To get this code to work, attached an OpenLCD to an Arduino Uno using the following pins:

RX (OpenLCD) to Pin 7 (Arduino)

VIN to 5V

GND to GND

Command cheat sheet:

ASCII / DEC / HEX

'|' / 124 / 0x7C - Put into setting mode

Ctrl+c / 3 / 0x03 - Change width to 20

Ctrl+d / 4 / 0x04 - Change width to 16

Ctrl+e / 5 / 0x05 - Change lines to 4

Ctrl+f / 6 / 0x06 - Change lines to 2

Ctrl+g / 7 / 0x07 - Change lines to 1

Ctrl+h / 8 / 0x08 - Software reset of the system

Ctrl+i / 9 / 0x09 - Enable/disable splash screen

Ctrl+j / 10 / 0x0A - Save currently displayed text as splash

Ctrl+k / 11 / 0x0B - Change baud to 2400bps

Ctrl+l / 12 / 0x0C - Change baud to 4800bps

Ctrl+m / 13 / 0x0D - Change baud to 9600bps

Ctrl+n / 14 / 0x0E - Change baud to 14400bps

Ctrl+o / 15 / 0x0F - Change baud to 19200bps

Ctrl+p / 16 / 0x10 - Change baud to 38400bps

Ctrl+q / 17 / 0x11 - Change baud to 57600bps

Ctrl+r / 18 / 0x12 - Change baud to 115200bps
 Ctrl+s / 19 / 0x13 - Change baud to 230400bps
 Ctrl+t / 20 / 0x14 - Change baud to 460800bps
 Ctrl+u / 21 / 0x15 - Change baud to 921600bps
 Ctrl+v / 22 / 0x16 - Change baud to 1000000bps
 Ctrl+w / 23 / 0x17 - Change baud to 1200bps
 Ctrl+x / 24 / 0x18 - Change the contrast. Follow Ctrl+x with number 0 to 255. 120 is default.
 Ctrl+y / 25 / 0x19 - Change the TWI address. Follow Ctrl+x with number 0 to 255. 114 (0x72) is default.
 Ctrl+z / 26 / 0x1A - Enable/disable ignore RX pin on startup (ignore emergency reset)
 '-' / 45 / 0x2D - Clear display. Move cursor to home position.
 / 128-157 / 0x80-0x9D - Set the primary backlight brightness. 128 = Off, 157 = 100%.
 / 158-187 / 0x9E-0xBB - Set the green backlight brightness. 158 = Off, 187 = 100%.
 / 188-217 / 0xBC-0xD9 - Set the blue backlight brightness. 188 = Off, 217 = 100%.

For example, to change the baud rate to 115200 send 124 followed by 18.

*/

```

#include <SoftwareSerial.h>

SoftwareSerial OpenLCD(6, 7); //RX (not used), TX

byte counter = 0;

void setup()
{
  Serial.begin(9600); //Begin local communication for debug statements

  OpenLCD.begin(9600); //Begin communication with OpenLCD

  OpenLCD.write('|'); //Put LCD into setting mode
  OpenLCD.write(158 + 0); //Set green backlight amount to 0%

  OpenLCD.write('|'); //Put LCD into setting mode
  OpenLCD.write(188 + 0); //Set blue backlight amount to 0%
}

void loop()
{
  //Control red backlight
  Serial.println("Mono/Red backlight set to 0%");
  OpenLCD.write('|'); //Put LCD into setting mode
  OpenLCD.write(128); //Set white/red backlight amount to 0%

  delay(2000);

  //Control red backlight
  Serial.println("Mono/Red backlight set to 51%");
  OpenLCD.write('|'); //Put LCD into setting mode
  OpenLCD.write(128 + 15); //Set white/red backlight amount to 51%

  delay(2000);

  //Control red backlight

```

```

Serial.println("Mono/Red backlight set to 100%");
OpenLCD.write('|'); //Put LCD into setting mode
OpenLCD.write(128 + 29); //Set white/red backlight amount to 100%

delay(2000);

//The following green and blue backlight control only apply if you have an RGB backlight enabled LCD

all_off(); // turn off all backlights - see function below

//Control green backlight
Serial.println("Green backlight set to 51%");
OpenLCD.write('|'); //Put LCD into setting mode
OpenLCD.write(158 + 15); //Set green backlight amount to 51%

delay(2000);

//Control green backlight
Serial.println("Green backlight set to 100%");
OpenLCD.write('|'); //Put LCD into setting mode
OpenLCD.write(158 + 29); //Set green backlight amount to 100%

delay(2000);

all_off(); // turn off all backlights - see function below

//Control blue backlight
Serial.println("Blue backlight set to 51%");
OpenLCD.write('|'); //Put LCD into setting mode
OpenLCD.write(188 + 15); //Set blue backlight amount to 51%

delay(2000);

//Control blue backlight
Serial.println("Blue backlight set to 100%");
OpenLCD.write('|'); //Put LCD into setting mode
OpenLCD.write(188 + 29); //Set blue backlight amount to 100%

delay(2000);

all_off(); // turn off all backlights - see function below
}

void all_off(void)
{
// Set all colors to 0

OpenLCD.write('|'); //Put LCD into setting mode
OpenLCD.write(128); //Set white/red backlight amount to 0%

OpenLCD.write('|'); //Put LCD into setting mode
OpenLCD.write(158 + 0); //Set green backlight amount to 0%

```

```

OpenLCD.write('|'); //Put LCD into setting mode
OpenLCD.write(188 + 0); //Set blue backlight amount to 0%

delay(2000);
}

```

And here is a table showing all of the available backlight settings and commands:

ASCII	DEC	HEX	Description
n/a	128-157	0x80-0x9D	Set the primary backlight brightness. 128 = Off, 157 = 100%.
n/a	158-187	0x9E-0xBB	Set the green backlight brightness. 158 = Off, 187 = 100%.
n/a	188-217	0xBC-0xD9	Set the blue backlight brightness. 188 = Off, 217 = 100%.

OpenLCD Backlight Command Set

Splash Screen

These LCD screens have a splash screen by default that reads “SparkFun OpenLCD Baud:9600”. This splash screen verifies that the unit is powered, working correctly, and that the connection to the LCD is correct. The splash screen is displayed for 500 ms during boot-up and may be turned off if desired.

Setting Splash Screen

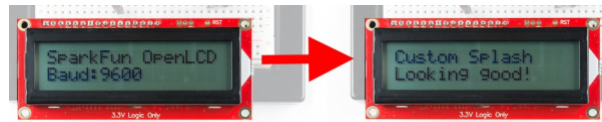

To make a custom splash screen, you need to send the characters you want to display (above we sent the characters “Custom Splash Looking good!”) followed by `|`, then `ctrl + j`). You will see a quick pop-up message display “Flash Recorded”. Cycle power to test. You can also try out the example sketch located in the github repo or copy and paste the code below into your Arduino IDE:

```
/*
OpenLCD is an LCD with serial/I2C/SPI interfaces.
By: Nathan Seidle, Pete Lewis
SparkFun Electronics
Date: 7/26/2018
License: This code is public domain but you buy me a beer if you use this and we meet someday
(Beerware license).
OpenLCD gives the user multiple interfaces (serial, I2C, and SPI) to control an LCD. SerLCD was
the original
serial LCD from SparkFun that ran on the PIC 16F88 with only a serial interface and limited fea
ture set.
This is an updated serial LCD.
```

This example shows how to change the Splash Screen contents. We assume the module is currently at default 9600bps.

We use software serial because if OpenLCD is attached to an Arduino's hardware serial port during bootloading

it can cause problems for both devices.

Note: If OpenLCD gets into an unknown state or you otherwise can't communicate with it send 18 (0x12 or ctrl+r)

at 9600 baud while the splash screen is active and the unit will reset to 9600 baud.

Emergency reset: If you get OpenLCD stuck into an unknown baud rate, unknown I2C address, etc, there is a

safety mechanism built-in. Tie the RX pin to ground and power up OpenLCD. You should see the splash screen

then "System reset Power cycle me" and the backlight will begin to blink. Now power down OpenLCD and remove

the RX/GND jumper. OpenLCD is now reset to 9600bps with a I2C address of 0x72. Note: This feature can be

disabled if necessary. See *Ignore Emergency Reset* for more information.

To get this code to work, attached an OpenLCD to an Arduino Uno using the following pins:

RX (OpenLCD) to Pin 7 (Arduino)

VIN to 5V

GND to GND

Command cheat sheet:

ASCII / DEC / HEX

'|' / 124 / 0x7C - Put into setting mode

Ctrl+c / 3 / 0x03 - Change width to 20

Ctrl+d / 4 / 0x04 - Change width to 16

Ctrl+e / 5 / 0x05 - Change lines to 4

Ctrl+f / 6 / 0x06 - Change lines to 2

Ctrl+g / 7 / 0x07 - Change lines to 1

Ctrl+h / 8 / 0x08 - Software reset of the system

Ctrl+i / 9 / 0x09 - Enable/disable splash screen

Ctrl+j / 10 / 0x0A - Save currently displayed text as splash

Ctrl+k / 11 / 0x0B - Change baud to 2400bps

Ctrl+l / 12 / 0x0C - Change baud to 4800bps

Ctrl+m / 13 / 0x0D - Change baud to 9600bps

Ctrl+n / 14 / 0x0E - Change baud to 14400bps

Ctrl+o / 15 / 0x0F - Change baud to 19200bps

Ctrl+p / 16 / 0x10 - Change baud to 38400bps

Ctrl+q / 17 / 0x11 - Change baud to 57600bps

Ctrl+r / 18 / 0x12 - Change baud to 115200bps
 Ctrl+s / 19 / 0x13 - Change baud to 230400bps
 Ctrl+t / 20 / 0x14 - Change baud to 460800bps
 Ctrl+u / 21 / 0x15 - Change baud to 921600bps
 Ctrl+v / 22 / 0x16 - Change baud to 1000000bps
 Ctrl+w / 23 / 0x17 - Change baud to 1200bps
 Ctrl+x / 24 / 0x18 - Change the contrast. Follow Ctrl+x with number 0 to 255. 120 is default.
 Ctrl+y / 25 / 0x19 - Change the TWI address. Follow Ctrl+x with number 0 to 255. 114 (0x72) is default.
 Ctrl+z / 26 / 0x1A - Enable/disable ignore RX pin on startup (ignore emergency reset)
 '-' / 45 / 0x2D - Clear display. Move cursor to home position.
 / 128-157 / 0x80-0x9D - Set the primary backlight brightness. 128 = Off, 157 = 100%.
 / 158-187 / 0x9E-0xBB - Set the green backlight brightness. 158 = Off, 187 = 100%.
 / 188-217 / 0xBC-0xD9 - Set the blue backlight brightness. 188 = Off, 217 = 100%.

For example, to change the baud rate to 115200 send 124 followed by 18.

*/

```
#include <SoftwareSerial.h>
```

```
SoftwareSerial OpenLCD(6, 7); //RX (not used), TX
```

```
void setup()
```

```
{
```

```
  Serial.begin(9600); //Begin local communication for debug statements
```

```
  OpenLCD.begin(9600); //Begin communication with OpenLCD
```

```
  delay(1000);
```

```
  OpenLCD.write('|'); //Put LCD into setting mode
```

```
  OpenLCD.write('-'); // clear screen
```

```
  delay(1000);
```

```
  OpenLCD.print("Custom Splash   Looking good!"); // Send our new content to display - this will soon become our new splash screen.
```

```
  OpenLCD.write('|'); //Put LCD into setting mode
```

```
  OpenLCD.write(10); //Set current contents to splash screen memory (this is also a "ctrl-j", if you are doing it manually)
```

```
}
```

```
void loop()
```

```
{
```

```
  // nothing here, just doing this example in setup()
```

```
}
```

Turning Splash Screen On/Off

To disable the splash screen, send | , then Ctrl + i . Every time this command is sent to the unit, the splash screen display option will toggle. If the splash screen is currently being displayed, sending | , then Ctrl + i will disable the splash screen during the next boot, and sending | , then Ctrl + i characters again will enable the

splash screen.

Serial UART: Hardware Hookup

Here's how to setup your hardware for most of the Serial UART example code.

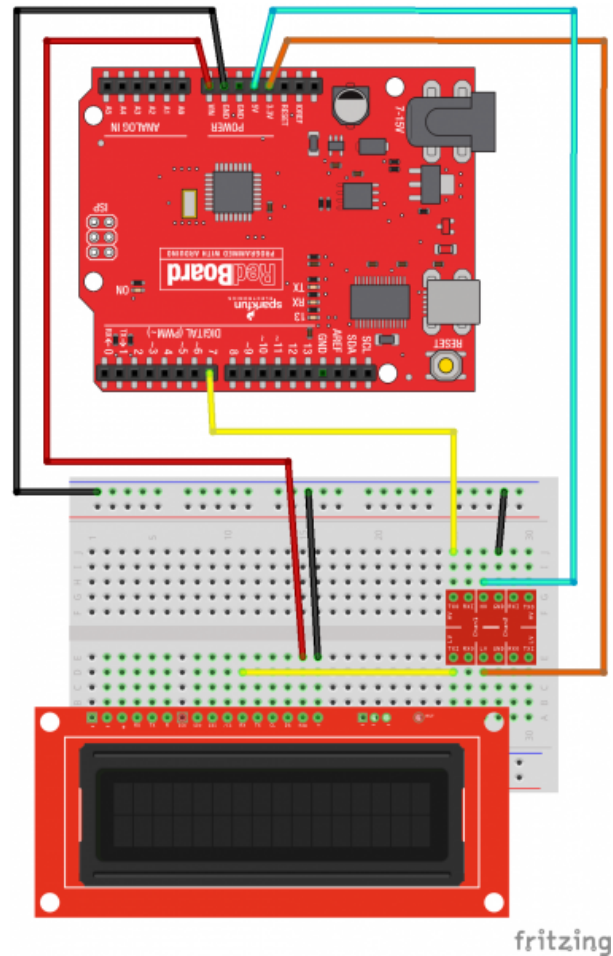

Note, some other examples require additional wiring (for example the contrast example requires a trimpot for variable control). We will show Fritzing graphics for each example covered in this tutorial. For the remaining tutorials, please look at the comments at the top of the example code for info on how to hookup the hardware.

Serial UART: Example Code - Basic

You can download the latest example code for this experiment from the github repo or you can copy and paste the following code into your Arduino IDE:

```

/*
OpenLCD is an LCD with serial/I2C/SPI interfaces.
By: Nathan Seidle
SparkFun Electronics
Date: April 19th, 2015
License: This code is public domain but you buy me a beer if you use this and we meet someday
(Beerware license).

This example shows how to display a counter on the display over serial. We use software serial
because if
OpenLCD is attached to an Arduino's hardware serial port during bootloading it can cause probl
ems for both devices.

To get this code to work, attached an OpenLCD to an Arduino Uno using the following pins:
RX (OpenLCD) to Pin 7 (Arduino)
VIN to 5V
GND to GND

*/

#include <SoftwareSerial.h>

SoftwareSerial OpenLCD(6, 7); //RX, TX

byte counter = 0;
byte contrast = 10;

void setup()
{
  Serial.begin(9600); //Start serial communication at 9600 for debug statements
  Serial.println("OpenLCD Example Code");

  OpenLCD.begin(9600); //Start communication with OpenLCD

  //Send contrast setting
  OpenLCD.write('|'); //Put LCD into setting mode

  OpenLCD.write(24); //Send contrast command
  OpenLCD.write(contrast);
}

void loop()
{
  //Send the clear command to the display - this returns the cursor to the beginning of the disp
lay
  OpenLCD.write('|'); //Setting character
  OpenLCD.write('-'); //Clear display

  OpenLCD.print("Hello World!   Counter: "); //For 16x2 LCD
  //OpenLCD.print("Hello World!           Counter: "); //For 20x4 LCD
  OpenLCD.print(counter++);

  delay(250); //Hang out for a bit

```

Here's what you should see after uploading the code to your Arduino. Try changing the text with a different message!

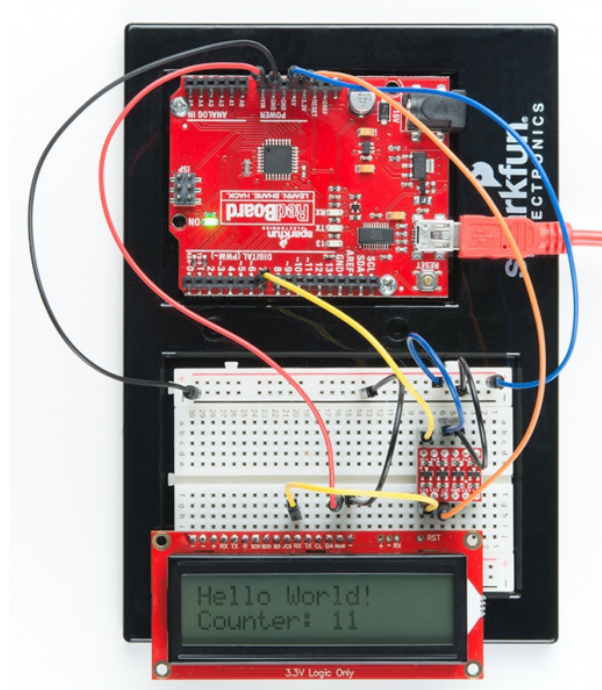

To send text to the board, wait 1/2 second (500ms) after power up for the splash screen to clear, then send text to the display through your serial port. The display understands all of the standard ASCII characters (upper and lowercase text, numbers, and punctuation), plus a number of graphic symbols and Japanese characters. See the HD44780 datasheet for the full list of supported characters.

If you send data that goes past the end of the first line, it will skip to the start of the second line. If you go past the end of the second line, the display will jump back up to the beginning of the first line.

Tip: You can simulate a scrolling window in software by copying the second line to the first line, and clearing the second line.

Serial UART: Example Code - Contrast Control with a Trimpot

For this contrast control example, you will need to wire up a trimpot. This will allow you to adjust the contrast in real time and find the best setting for your environment. Wire things up like this:

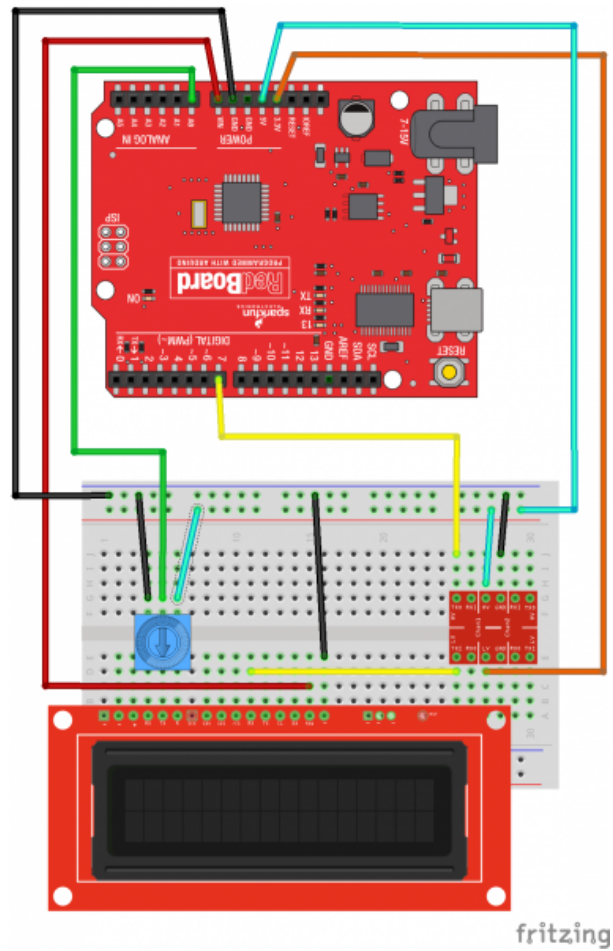

You can download the latest example code for this experiment from the github repo or you can copy and paste the following code into your Arduino IDE:

```
/*
OpenLCD is an LCD with Serial/I2C/SPI interfaces.
By: Nathan Seidle
SparkFun Electronics
Date: April 19th, 2015
License: This code is public domain but you buy me a beer if you use this and we meet someday
(Beerware license).

OpenLCD gives the user multiple interfaces (serial, I2C, and SPI) to control an LCD. SerLCD was
the original
serial LCD from SparkFun that ran on the PIC 16F88 with only a serial interface and limited fea
ture set.
This is an updated serial LCD.

This example shows how to change the contrast using a trimpot. We assume the module is currentl
y at
default 9600bps.

We use software serial because if OpenLCD is attached to an Arduino's hardware serial port duri
ng bootloading
it can cause problems for both devices.

Note: If OpenLCD gets into an unknown state or you otherwise can't communicate with it send 18
(0x12 or ctrl+r)
at 9600 baud while the splash screen is active and the unit will reset to 9600 baud.

Emergency reset: If you get OpenLCD stuck into an unknown baud rate, unknown I2C address, etc,
there is a
safety mechanism built-in. Tie the RX pin to ground and power up OpenLCD. You should see the sp
lash screen
then "System reset Power cycle me" and the backlight will begin to blink. Now power down OpenLC
D and remove
the RX/GND jumper. OpenLCD is now reset to 9600bps with a I2C address of 0x72. Note: This featu
re can be
disabled if necessary. See *Ignore Emergency Reset* for more information.

To get this code to work, attached an OpenLCD to an Arduino Uno using the following pins:
RX (OpenLCD) to Pin 7 (Arduino)
VIN to 5V
GND to GND

Hook a trimpot up:
Pin 1 - 5V
Pin 2 - A0
Pin 3 - GND

*/

#include <SoftwareSerial.h>

SoftwareSerial OpenLCD(6, 7); //RX (not used), TX

byte counter = 0;
```

```

void setup()
{
  Serial.begin(9600); //Start serial communication at 9600 for debug statements
  Serial.println("OpenLCD Example Code");

  OpenLCD.begin(9600); //Begin communication with OpenLCD

  //Send the reset command to the display - this forces the cursor to return to the beginning of
  the display
  OpenLCD.write('|'); //Send setting character
  OpenLCD.write('-'); //Send clear display character
  OpenLCD.print("Contrast test");

  pinMode(A0, INPUT);
}

int oldContrast = 0;
long startTime = 0;
bool settingSent = false;

void loop()
{
  int trimpot = averageAnalogRead(A0);
  int newContrast = map(trimpot, 0, 1023, 0, 255); //Map this analog value down to 0-255

  //Only send new contrast setting to display if the user changes the trimpot
  if(newContrast != oldContrast)
  {
    Serial.print("nc: ");
    Serial.println(newContrast);

    oldContrast = newContrast; //Update

    startTime = millis();
    settingSent = false;
  }

  //Wait at least 100ms for user to stop turning trimpot
  //OpenLCD displays the contrast setting for around 2 seconds so we can't send constant updates
  if(millis() - startTime > 500 && settingSent == false)
  {
    //Send contrast setting
    OpenLCD.write('|'); //Put LCD into setting mode
    OpenLCD.write(24); //Send contrast command
    OpenLCD.write(newContrast);

    settingSent = true;

    Serial.print("New contrast: ");
    Serial.println(newContrast);
  }

  delay(100); //Hang out for a bit

```

```

}

//Takes an average of readings on a given pin
//Returns the average
int averageAnalogRead(byte pinToRead)
{
  byte numberOfReadings = 8;
  unsigned int runningValue = 0;

  for(int x = 0 ; x < numberOfReadings ; x++)
    runningValue += analogRead(pinToRead);
  runningValue /= numberOfReadings;

  return(runningValue);
}

```

After uploading your sketch, you can now try adjusting the trimpot and watch the contrast change in real time. Here are a few examples that I see:

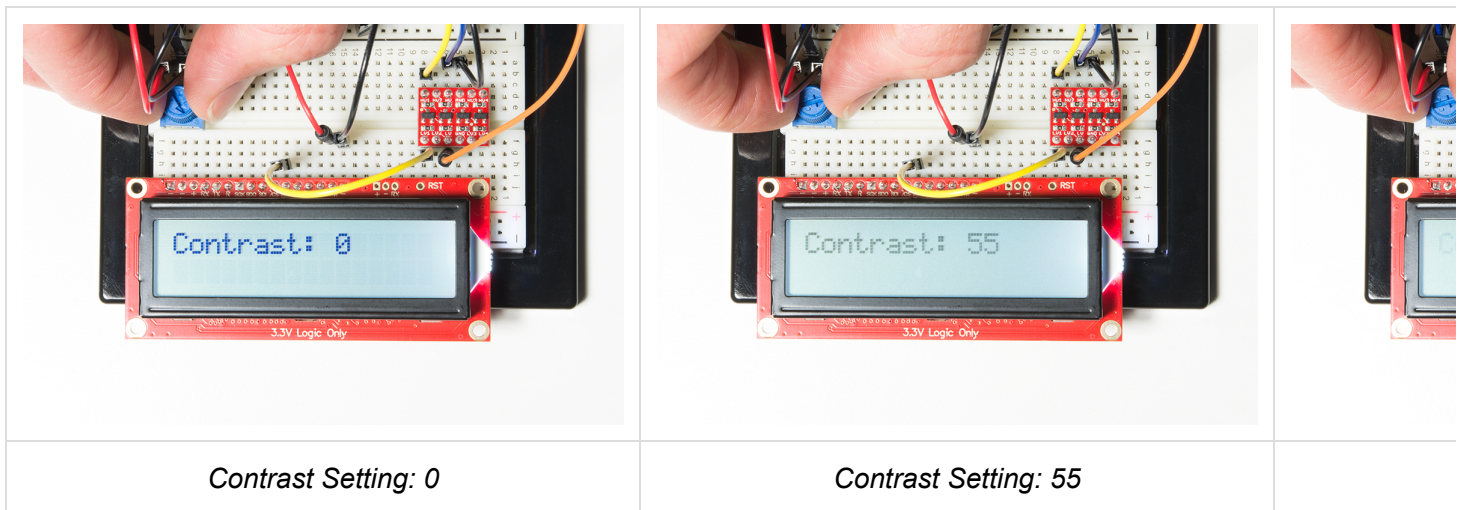

Note, if you are not seeing any text in the LCD, make sure and try rotating to either extreme. If you are up above 100, then in some cases you may not see any text. Watching your serial monitor from your Arduino can be helpful as well. It will tell you the settings as you are sending them to the LCD. Here is some example serial debug that I see while I adjust the trimpot:

```
COM4
OpenLCD Example Code
nc: 23
New contrast: 23
nc: 24
nc: 23
New contrast: 23
nc: 24
New contrast: 24
nc: 33
nc: 42
nc: 43
nc: 44
nc: 43
nc: 44
nc: 43
nc: 44
New contrast: 44
nc: 43
nc: 44
nc: 43
New contrast: 43
```

Serial UART: Example Code - Backlight Control

For this next example, you can use the same exact hardware setup as in the previous two examples (Serial Basic or Serial Contrast). To jump right in and start playing with backlight control, you can get the latest example code from the github repo or you can copy and paste the following code into your Arduino IDE:

```
/*
OpenLCD is an LCD with serial/I2C/SPI interfaces.
By: Nathan Seidle
SparkFun Electronics
Date: April 19th, 2015
License: This code is public domain but you buy me a beer if you use this and we meet someday
(Beerware license).
OpenLCD gives the user multiple interfaces (serial, I2C, and SPI) to control an LCD. SerLCD was
the original
serial LCD from SparkFun that ran on the PIC 16F88 with only a serial interface and limited fea
ture set.
This is an updated serial LCD.
```

This example shows how to change the backlight brightness. We assume the module is currently at default 9600bps.

We use software serial because if OpenLCD is attached to an Arduino's hardware serial port during bootloading

it can cause problems for both devices.

Note: If OpenLCD gets into an unknown state or you otherwise can't communicate with it send 18 (0x12 or ctrl+r)

at 9600 baud while the splash screen is active and the unit will reset to 9600 baud.

Emergency reset: If you get OpenLCD stuck into an unknown baud rate, unknown I2C address, etc, there is a

safety mechanism built-in. Tie the RX pin to ground and power up OpenLCD. You should see the splash screen

then "System reset Power cycle me" and the backlight will begin to blink. Now power down OpenLCD and remove

the RX/GND jumper. OpenLCD is now reset to 9600bps with a I2C address of 0x72. Note: This feature can be

disabled if necessary. See *Ignore Emergency Reset* for more information.

To get this code to work, attached an OpenLCD to an Arduino Uno using the following pins:

RX (OpenLCD) to Pin 7 (Arduino)

VIN to 5V

GND to GND

Command cheat sheet:

ASCII / DEC / HEX

'|' / 124 / 0x7C - Put into setting mode

Ctrl+c / 3 / 0x03 - Change width to 20

Ctrl+d / 4 / 0x04 - Change width to 16

Ctrl+e / 5 / 0x05 - Change lines to 4

Ctrl+f / 6 / 0x06 - Change lines to 2

Ctrl+g / 7 / 0x07 - Change lines to 1

Ctrl+h / 8 / 0x08 - Software reset of the system

Ctrl+i / 9 / 0x09 - Enable/disable splash screen

Ctrl+j / 10 / 0x0A - Save currently displayed text as splash

Ctrl+k / 11 / 0x0B - Change baud to 2400bps

Ctrl+l / 12 / 0x0C - Change baud to 4800bps

Ctrl+m / 13 / 0x0D - Change baud to 9600bps

Ctrl+n / 14 / 0x0E - Change baud to 14400bps

Ctrl+o / 15 / 0x0F - Change baud to 19200bps

Ctrl+p / 16 / 0x10 - Change baud to 38400bps

Ctrl+q / 17 / 0x11 - Change baud to 57600bps

Ctrl+r / 18 / 0x12 - Change baud to 115200bps
 Ctrl+s / 19 / 0x13 - Change baud to 230400bps
 Ctrl+t / 20 / 0x14 - Change baud to 460800bps
 Ctrl+u / 21 / 0x15 - Change baud to 921600bps
 Ctrl+v / 22 / 0x16 - Change baud to 1000000bps
 Ctrl+w / 23 / 0x17 - Change baud to 1200bps
 Ctrl+x / 24 / 0x18 - Change the contrast. Follow Ctrl+x with number 0 to 255. 120 is default.
 Ctrl+y / 25 / 0x19 - Change the TWI address. Follow Ctrl+x with number 0 to 255. 114 (0x72) is default.
 Ctrl+z / 26 / 0x1A - Enable/disable ignore RX pin on startup (ignore emergency reset)
 '-' / 45 / 0x2D - Clear display. Move cursor to home position.
 / 128-157 / 0x80-0x9D - Set the primary backlight brightness. 128 = Off, 157 = 100%.
 / 158-187 / 0x9E-0xBB - Set the green backlight brightness. 158 = Off, 187 = 100%.
 / 188-217 / 0xBC-0xD9 - Set the blue backlight brightness. 188 = Off, 217 = 100%.

For example, to change the baud rate to 115200 send 124 followed by 18.

*/

```

#include <SoftwareSerial.h>

SoftwareSerial OpenLCD(6, 7); //RX (not used), TX

byte counter = 0;

void setup()
{
  Serial.begin(9600); //Begin local communication for debug statements

  OpenLCD.begin(9600); //Begin communication with OpenLCD

  OpenLCD.write('|'); //Put LCD into setting mode
  OpenLCD.write(158 + 0); //Set green backlight amount to 0%

  OpenLCD.write('|'); //Put LCD into setting mode
  OpenLCD.write(188 + 0); //Set blue backlight amount to 0%
}

void loop()
{
  //Control red backlight
  Serial.println("Mono/Red backlight set to 0%");
  OpenLCD.write('|'); //Put LCD into setting mode
  OpenLCD.write(128); //Set white/red backlight amount to 0%

  delay(2000);

  //Control red backlight
  Serial.println("Mono/Red backlight set to 51%");
  OpenLCD.write('|'); //Put LCD into setting mode
  OpenLCD.write(128 + 15); //Set white/red backlight amount to 51%

  delay(2000);

  //Control red backlight

```

```

Serial.println("Mono/Red backlight set to 100%");
OpenLCD.write('|'); //Put LCD into setting mode
OpenLCD.write(128 + 29); //Set white/red backlight amount to 100%

delay(2000);

//The following green and blue backlight control only apply if you have an RGB backlight enabled LCD

all_off(); // turn off all backlights - see function below

//Control green backlight
Serial.println("Green backlight set to 51%");
OpenLCD.write('|'); //Put LCD into setting mode
OpenLCD.write(158 + 15); //Set green backlight amount to 51%

delay(2000);

//Control green backlight
Serial.println("Green backlight set to 100%");
OpenLCD.write('|'); //Put LCD into setting mode
OpenLCD.write(158 + 29); //Set green backlight amount to 100%

delay(2000);

all_off(); // turn off all backlights - see function below

//Control blue backlight
Serial.println("Blue backlight set to 51%");
OpenLCD.write('|'); //Put LCD into setting mode
OpenLCD.write(188 + 15); //Set blue backlight amount to 51%

delay(2000);

//Control blue backlight
Serial.println("Blue backlight set to 100%");
OpenLCD.write('|'); //Put LCD into setting mode
OpenLCD.write(188 + 29); //Set blue backlight amount to 100%

delay(2000);

all_off(); // turn off all backlights - see function below
}

void all_off(void)
{
// Set all colors to 0

OpenLCD.write('|'); //Put LCD into setting mode
OpenLCD.write(128); //Set white/red backlight amount to 0%

OpenLCD.write('|'); //Put LCD into setting mode
OpenLCD.write(158 + 0); //Set green backlight amount to 0%

```

```
OpenLCD.write('|'); //Put LCD into setting mode
OpenLCD.write(188 + 0); //Set blue backlight amount to 0%

delay(2000);
}
```

With this code running, you should see your backlight colors cycle through a pattern of 0%, then 50%, then 100%. It will show this for each color individually (Red, Green, and Blue). Here are some shots of what it looks like for me when I run the code. Note, yours may vary slightly due to your RAW input voltage and the temperature of your environment.

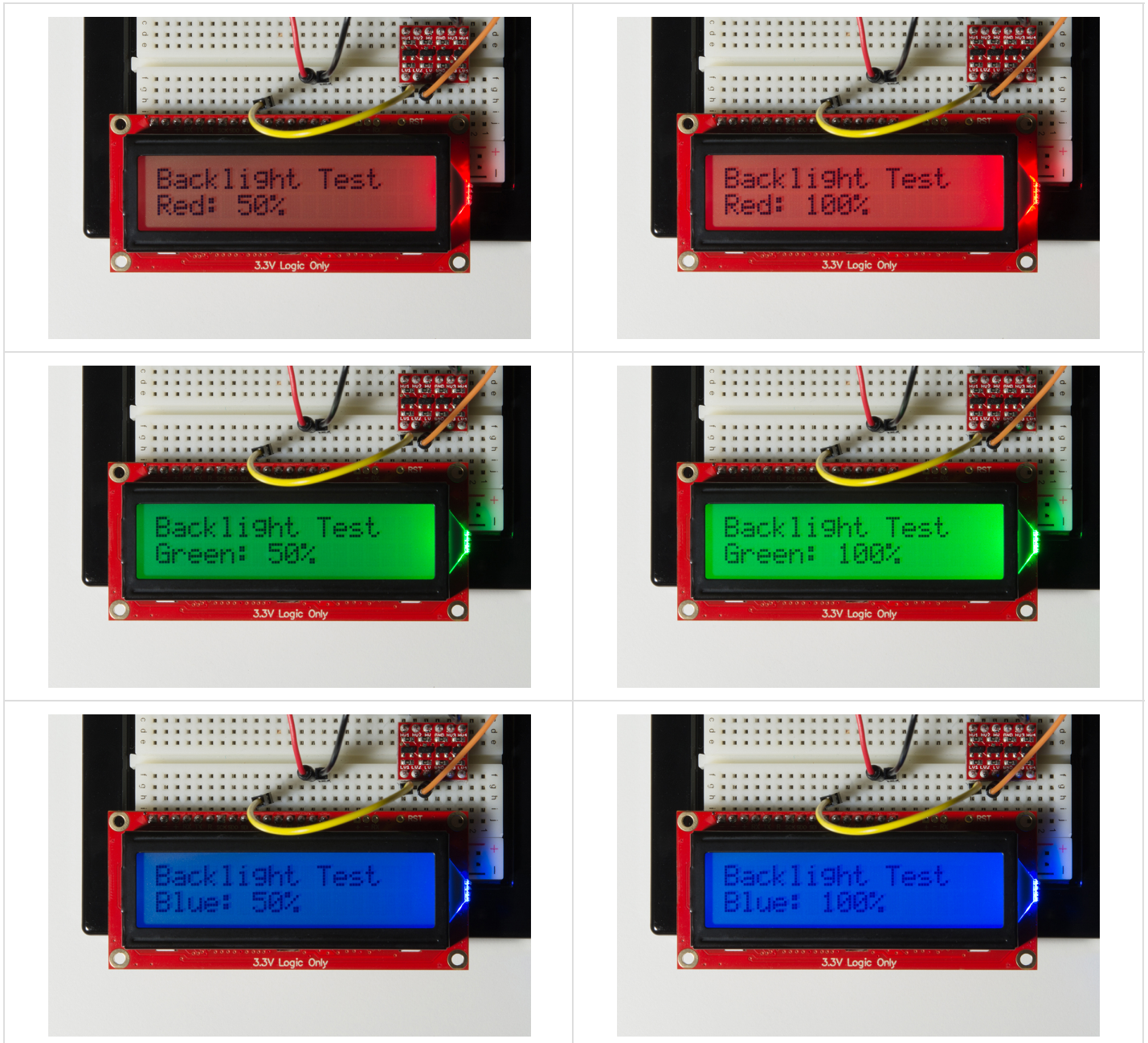

Tip: By mixing the amounts of each backlight color, you can create virtually any color you like. In the examples above, we are trying out each backlight on its own. For other colors, try combining different values

of each backlight. For example, to make a purple, you can try RED:29, GREEN:5, and BLUE:25. To make a yellow, try RED:22, GREEN:29, and BLUE:5. To make white, turn them all on to 29 (aka 100%).

I²C: Hardware Hookup & Example Code - Basic

For I²C, there are only 2 communication lines you need to connect: SDA and CLK. But remember, these *must* be 3.3V logic. So if you are using a 5V Redboard like we are, then you'll need to convert SDA and SCL from 5V to 3.3V. See the following Fritzing diagram for how you can wire this up:

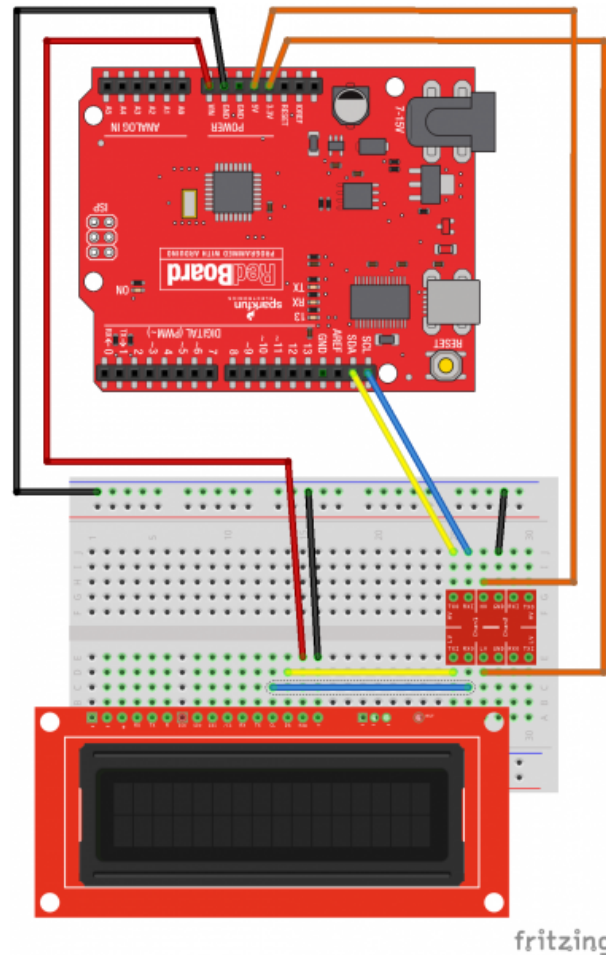

After you've got your I²C lines wired up properly, you can get the latest example code from the github repo or you can copy and paste the following code into your Arduino IDE:

```

/*
OpenLCD is an LCD with Serial/I2C/SPI interfaces.
By: Nathan Seidle

SparkFun Electronics
Date: April 19th, 2015
License: This code is public domain but you buy me a beer if you use this and we meet someday
(Beerware license).
This is example code that shows how to send data over I2C to the display.
Note: This code expects the display to be listening at the default I2C address. If your display
is not at 0x72, you can
do a hardware reset. Tie the RX pin to ground and power up OpenLCD. You should see the splash s
creen
then "System reset Power cycle me" and the backlight will begin to blink. Now power down OpenLC
D and remove
the RX/GND jumper. OpenLCD is now reset.
To get this code to work, attached an OpenLCD to an Arduino Uno using the following pins:
SCL (OpenLCD) to A5 (Arduino)
SDA to A4
VIN to 5V
GND to GND
Command cheat sheet:
ASCII / DEC / HEX
'|' / 124 / 0x7C - Put into setting mode
Ctrl+c / 3 / 0x03 - Change width to 20
Ctrl+d / 4 / 0x04 - Change width to 16
Ctrl+e / 5 / 0x05 - Change lines to 4
Ctrl+f / 6 / 0x06 - Change lines to 2
Ctrl+g / 7 / 0x07 - Change lines to 1
Ctrl+h / 8 / 0x08 - Software reset of the system
Ctrl+i / 9 / 0x09 - Enable/disable splash screen
Ctrl+j / 10 / 0x0A - Save currently displayed text as splash
Ctrl+k / 11 / 0x0B - Change baud to 2400bps
Ctrl+l / 12 / 0x0C - Change baud to 4800bps
Ctrl+m / 13 / 0x0D - Change baud to 9600bps
Ctrl+n / 14 / 0x0E - Change baud to 14400bps
Ctrl+o / 15 / 0x0F - Change baud to 19200bps
Ctrl+p / 16 / 0x10 - Change baud to 38400bps
Ctrl+q / 17 / 0x11 - Change baud to 57600bps
Ctrl+r / 18 / 0x12 - Change baud to 115200bps
Ctrl+s / 19 / 0x13 - Change baud to 230400bps
Ctrl+t / 20 / 0x14 - Change baud to 460800bps
Ctrl+u / 21 / 0x15 - Change baud to 921600bps
Ctrl+v / 22 / 0x16 - Change baud to 1000000bps
Ctrl+w / 23 / 0x17 - Change baud to 1200bps
Ctrl+x / 24 / 0x18 - Change the contrast. Follow Ctrl+x with number 0 to 255. 120 is default.
Ctrl+y / 25 / 0x19 - Change the TWI address. Follow Ctrl+x with number 0 to 255. 114 (0x72) is
default.
Ctrl+z / 26 / 0x1A - Enable/disable ignore RX pin on startup (ignore emergency reset)
'-' / 45 / 0x2D - Clear display. Move cursor to home position.
    / 128-157 / 0x80-0x9D - Set the primary backlight brightness. 128 = Off, 157 = 100%.
    / 158-187 / 0x9E-0xBB - Set the green backlight brightness. 158 = Off, 187 = 100%.
    / 188-217 / 0xBC-0xD9 - Set the blue backlight brightness. 188 = Off, 217 = 100%.
For example, to change the baud rate to 115200 send 124 followed by 18.

```

```

*/

#include <Wire.h>

#define DISPLAY_ADDRESS1 0x72 //This is the default address of the OpenLCD

int cycles = 0;

void setup()
{
  Wire.begin(); //Join the bus as master

  //By default .begin() will set I2C SCL to Standard Speed mode of 100kHz
  //Wire.setClock(400000); //Optional - set I2C SCL to High Speed Mode of 400kHz

  Serial.begin(9600); //Start serial communication at 9600 for debug statements
  Serial.println("OpenLCD Example Code");

  //Send the reset command to the display - this forces the cursor to return to the beginning of
  the display
  Wire.beginTransmission(DISPLAY_ADDRESS1);
  Wire.write('|'); //Put LCD into setting mode
  Wire.write('-'); //Send clear display command
  Wire.endTransmission();
}

void loop()
{
  cycles++; //Counting cycles! Yay!
  // Serial.print("Cycle: "); //These serial.print statements take multiple milliseconds
  // Serial.println(cycles);

  i2cSendValue(cycles); //Send the four characters to the display

  delay(50); //The maximum update rate of OpenLCD is about 100Hz (10ms). A smaller delay will ca
use flicker
}

//Given a number, i2cSendValue chops up an integer into four values and sends them out over I2C
void i2cSendValue(int value)
{
  Wire.beginTransmission(DISPLAY_ADDRESS1); // transmit to device #1

  Wire.write('|'); //Put LCD into setting mode
  Wire.write('-'); //Send clear display command

  Wire.print("Cycles: ");
  Wire.print(value);

  Wire.endTransmission(); //Stop I2C transmission
}

```



```

/*
OpenLCD is an LCD with Serial/I2C/SPI interfaces.
By: Nathan Seidle
SparkFun Electronics

Date: April 19th, 2015
License: This code is public domain but you buy me a beer if you use this and we meet someday
(Beerware license).

This is example code that shows how to send data over SPI to the display.

To get this code to work, attached an OpenLCD to an Arduino Uno using the following pins:
CS (OpenLCD) to 10 (Arduino)
SDI to 11
SDO to 12 (optional)
SCK to 13
VIN to 5V
GND to GND

Command cheat sheet:
ASCII / DEC / HEX
'|' / 124 / 0x7C - Put into setting mode
Ctrl+c / 3 / 0x03 - Change width to 20
Ctrl+d / 4 / 0x04 - Change width to 16
Ctrl+e / 5 / 0x05 - Change lines to 4
Ctrl+f / 6 / 0x06 - Change lines to 2
Ctrl+g / 7 / 0x07 - Change lines to 1
Ctrl+h / 8 / 0x08 - Software reset of the system
Ctrl+i / 9 / 0x09 - Enable/disable splash screen
Ctrl+j / 10 / 0x0A - Save currently displayed text as splash
Ctrl+k / 11 / 0x0B - Change baud to 2400bps
Ctrl+l / 12 / 0x0C - Change baud to 4800bps
Ctrl+m / 13 / 0x0D - Change baud to 9600bps
Ctrl+n / 14 / 0x0E - Change baud to 14400bps
Ctrl+o / 15 / 0x0F - Change baud to 19200bps
Ctrl+p / 16 / 0x10 - Change baud to 38400bps
Ctrl+q / 17 / 0x11 - Change baud to 57600bps
Ctrl+r / 18 / 0x12 - Change baud to 115200bps
Ctrl+s / 19 / 0x13 - Change baud to 230400bps
Ctrl+t / 20 / 0x14 - Change baud to 460800bps
Ctrl+u / 21 / 0x15 - Change baud to 921600bps
Ctrl+v / 22 / 0x16 - Change baud to 1000000bps
Ctrl+w / 23 / 0x17 - Change baud to 1200bps
Ctrl+x / 24 / 0x18 - Change the contrast. Follow Ctrl+x with number 0 to 255. 120 is default.
Ctrl+y / 25 / 0x19 - Change the TWI address. Follow Ctrl+x with number 0 to 255. 114 (0x72) is
default.
Ctrl+z / 26 / 0x1A - Enable/disable ignore RX pin on startup (ignore emergency reset)
'-' / 45 / 0x2D - Clear display. Move cursor to home position.
/ 128-157 / 0x80-0x9D - Set the primary backlight brightness. 128 = Off, 157 = 100%.
/ 158-187 / 0x9E-0xBB - Set the green backlight brightness. 158 = Off, 187 = 100%.
/ 188-217 / 0xBC-0xD9 - Set the blue backlight brightness. 188 = Off, 217 = 100%.

For example, to change the baud rate to 115200 send 124 followed by 18.
*/

```



```

#include <SPI.h>

int csPin = 10; //You can use any output pin but for this example we use 10

int cycles = 0;

void setup()
{
  pinMode(csPin, OUTPUT);
  digitalWrite(csPin, HIGH); //By default, don't be selecting OpenLCD

  SPI.begin(); //Start SPI communication
  //SPI.beginTransaction(SPISettings(100000, MSBFIRST, SPI_MODE0));
  SPI.setClockDivider(SPI_CLOCK_DIV128); //Slow down the master a bit
}

void loop()
{
  cycles++; //Counting cycles! Yay!

  //Send the clear display command to the display - this forces the cursor to return to the beginning of the display
  digitalWrite(csPin, LOW); //Drive the CS pin low to select OpenLCD
  SPI.transfer('|'); //Put LCD into setting mode
  SPI.transfer('-'); //Send clear display command
  digitalWrite(csPin, HIGH); //Release the CS pin to de-select OpenLCD

  char tempString[50]; //Needs to be large enough to hold the entire string with up to 5 digits
  sprintf(tempString, "Cycles: %d", cycles);
  spiSendString(tempString);

  //25ms works well
  //15ms slight flickering
  //5ms causes flickering
  delay(250);
}

//Sends a string over SPI
void spiSendString(char* data)
{
  digitalWrite(csPin, LOW); //Drive the CS pin low to select OpenLCD
  for(byte x = 0 ; data[x] != '\0' ; x++) //Send chars until we hit the end of the string
    SPI.transfer(data[x]);
  digitalWrite(csPin, HIGH); //Release the CS pin to de-select OpenLCD
}

```

Troubleshooting

Random Character

If the display is powered up without the RX line connected to anything, the display may fill with strange characters. This is because the display is receiving random noise on the disconnected line. If you connect the RX line to a true TX port, this will not happen.

Faded Characters on Display

If the display is unreadable or washed out, the contrast may need to be adjusted. This is done in software, so you will need to send your display some contrast control commands via Serial UART, I²C or SPI. There is a specific example for each of these communication types inside the github repository here:

- [Example2_Serial_Contrast](#)
- [Example2_I2C_Contrast](#)
- You can also follow along with the example in this tutorial above: [click here](#).

Emergency Reset

If your LCD screen has entered an unknown state, or you are unable to communicate with it, it's probably a good idea to try resetting everything back to default settings. The OpenLCD firmware has a built-in "emergency reset" feature. When the screen first boots up, the AVR on the back will watch its RX pin. If that pin is held LOW (aka tied to ground), for 2 seconds, then it will reset all settings to default. Most importantly, your baud rate will be set back to 9600. After the reset is complete, the screen will display the message "System Reset Power Cycle Me", and flicker the backlight on and off repeatedly until you cycle power.

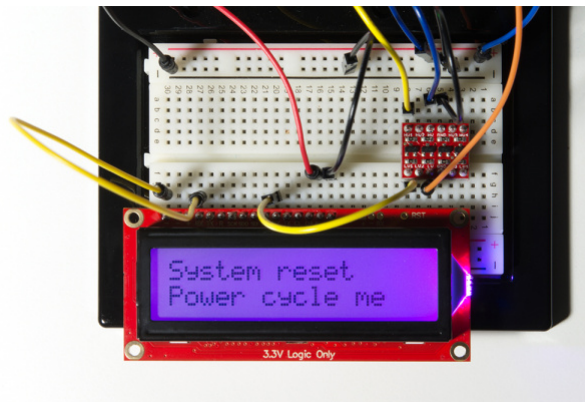

To perform an emergency reset, please be sure to follow these exact steps in this order:

- Ensure your screen is OFF.
- Tie RX to GND.
- Power your screen.
- Wait 2 seconds. Verify "System Reset" message.
- Remove connection from RX to GND.
- Cycle Power.

Now, please enjoy your default settings (including 9600 baud).

Firmware Update

To update the firmware on your LCD, you can use an FTDI Basic 3.3V - beefy model and the Arduino IDE software. The AVR on the back of your LCD actually has an Arduino-compatible bootloader. That said, it is slightly custom in that it was compiled for the 11.0592 crystal. This means you will need to install the SparkFun AVR Boards, and then select "Sparkfun OpenLCD" as your board type.

If you've made it this far, presumably you have the latest version of the Arduino IDE on your desktop. If you do not, please review our tutorial on installing the Arduino IDE.

Here's the tutorial for installing custom board packages:

INSTALLING CUSTOM BOARD PACKAGES

Once you have that installed, you should see "SparkFun OpenLCD" as a board option from the drop down menu here:

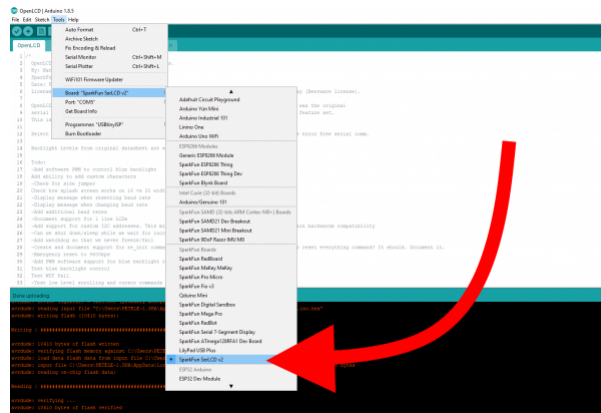

Now plug in your serial FTDI basic into your LCD screen.

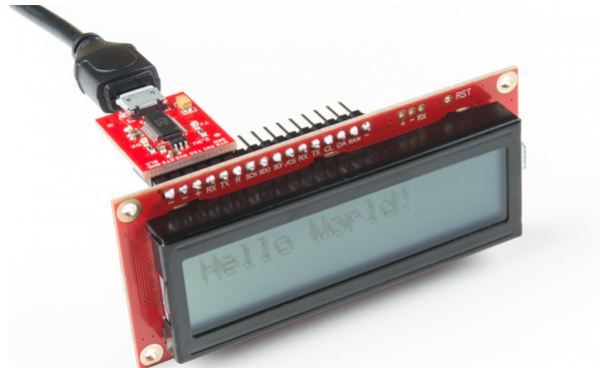

Make sure to line it up properly so the "-" is lined up with the "GND", and the "R" is lined up with "DTR".

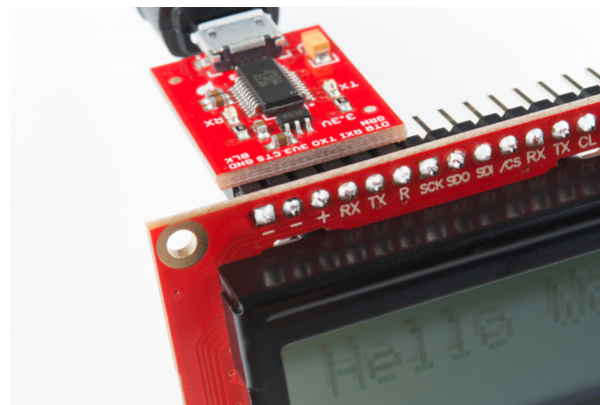

Grab the latest firmware located here:

[OPEN LCD FIRMWARE DOWNLOAD](#)

Note, you will need all of the files in the “<https://github.com/sparkfun/OpenLCD/blob/master/firmware/OpenLCD/>” directory. When you open the OpenLCD.ino sketch in arduino, the other necessary files will open as tabs.

- OpenLCD.ino
- Setting_Control.ino
- System_Functions.ino
- settings.h

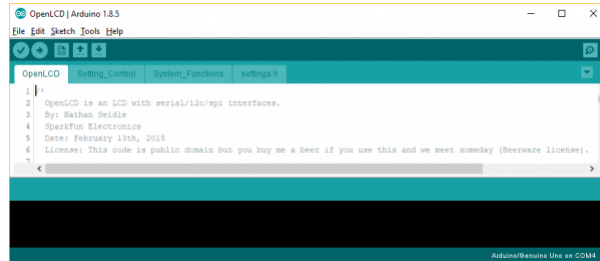

Click the UPLOAD button in the IDE (the right facing arrow), and this will get the latest code onto your LCD!

Note, any of the settings stored in EEPROM memory (like baud, splash screen contents, backlight settings, etc.) will not be overwritten. If you are using a fresh IC (or you erased your EEPROM), then all of the defaults will return. To reset these settings to default, you must perform an “Emergency Reset”. The instructions for this are in another part of this troubleshooting section.

Using the Serial Enabled LCD on an Atmega32U4’s Hardware UART

If you are using the serial enabled LCD with an Atmega32U4-based Arduino (like a Pro Micro, Arduino Leonardo, Arduino LilyPad USB, etc), you might need to add a small delay in the setup before you can get it working with the hardware UART (pins 0 and 1). Here’s an example:

```
///test example using ATmega32U4's hardware UART and delay
void setup() {
  delay(2000); //add delay so the ATmega32U4 can have a second before sending serial data to the
  LCD
  Serial1.begin(9600); //set up the hardware UART baud
}

void loop() {
  Serial1.print("print something"); //send something to the serial enabled LCD
  delay(50);
}
```

Software Serial for Arduino Due

Unfortunately, you are not able to use the serial enabled LCDs with an Arduino Due due the differences in how change interrupts are used for the ARM processor. The software serial library is not included in the Arduino Due’s tree:

ARDUINO.CC FORUMS - SOFTWARE SERIAL FOR ARDUINO DUE?

Try using the other hardware serial UARTs that are not connected to the Arduino Due’s programming pins for uploading. Make sure to adjust the code for the hardware serial UART.

Resources and Going Further

Now that you've successfully got your OpenLCD up and running, it's time to incorporate it into your own project! When it is complete (or even during the design and build phases) please share in comments section of this tutorial, we'd love to hear about it! We also like doing project highlights, so please don't hesitate to reach out when it's finished. Maybe we could even feature your project with a blog post and video!

Also, if you ran into any issues during this hookup guide, or something wasn't crystal clear the first time you read it, please let us know in the comments section of this tutorial. We strive to make the best documentation possible, and really want to hear about any pain points you discovered. Thanks in advance!

For more information, check out the resources below:

- [OpenLCD GitHub Repo](#) - OpenLCD design files, default firmware, and example code.
- [HD44780](#)
 - [Datasheet](#)
 - [LCD User-Defined Graphics](#) - If you would like to create a custom character, you would need to send a command byte before controlling the individual pixels in the character square.

Need some inspiration for your next project? Check out some of these related tutorials:

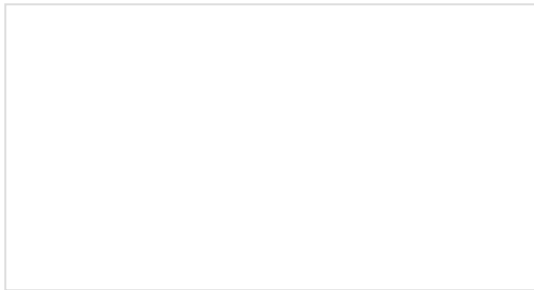

Graphic LCD Hookup Guide

How to add some flashy graphics to your project with a 84x48 monochrome graphic LCD.

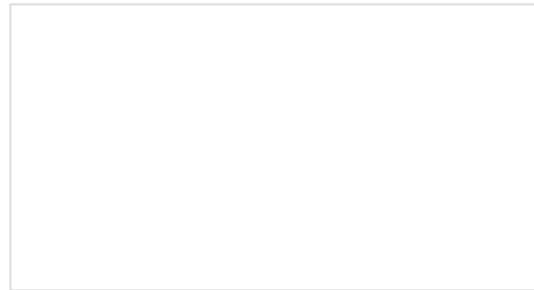

MYST Linking Book

Create your own Linking Book from the classic computer game, MYST

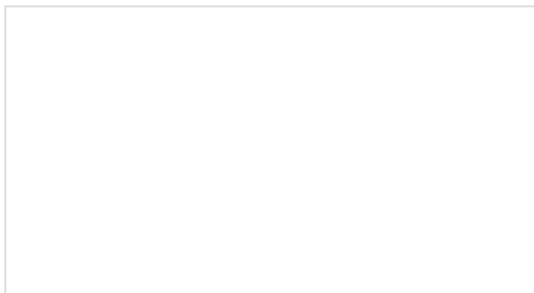

ELasto-Nightlight

Fear the dark no longer with this ELastoLite nightlight.

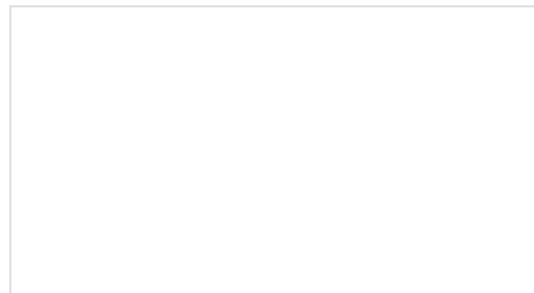

SparkFun Blocks for Intel® Edison - OLED Block

A quick overview of the features of the OLED Block for the Edison.